



FOR AMERICAN FORGE & FOUNDRY™



**Heavy-Duty and Automotive
Service Equipment for Professionals**

The **AFF** Total Value Commitment

Since 1963, American Forge and Foundry has provided a full selection of "Forge-Tough" hydraulic lifting products, lubrication tools, and general shop equipment.

Serving Repair Shops, Maintenance Facilities, Heavy Duty Fleets, Industrial Applications, and Agribusiness, the AFF brand is synonymous with durability and dependability.

It is quite common to see the AFF brand of products being used in Professional Automotive, Trucking, Bus, Construction and even the Aircraft industry. This is a true testament to our dedication to providing the Professional user with a quality product built to meet the needs of very demanding industries.

Despite heavy use in professional shops across America, it is very common to find AFF equipment still in active duty after many years of service. That is why thousands of professional technicians depend upon the durable AFF brand to help them get their daily work done more efficiently!

SALES AND SERVICE

AFF has always earned high marks with customers for dependable and courteous service that is truly second to none. The AFF team work hard to make it simple and painless to do business. Answers to your AFF product questions are just a fax, phone call or e-mail away.

Somewhat unique these days, AFF is also very proud to have one of the highest fill rates and quickest order processing turnarounds in the industry.

And... with over 250 authorized Repair Depot's and thousands of repair parts in stock, AFF will help keep your equipment working and on the job.

American Forge and Foundry has a long-standing tradition of providing quality, value, selection, and quick delivery!

Thank you again for your business and as always... work safe!



Visit our web site at www.affjaxx.com

Phone: (518)861-0101 (800)255-0555 Fax: (518)861-0099 sales@affjaxx.com

American Forge and Foundry has made every effort to provide accurate and up-to-date features, specifications and photos of our products for your information. American Forge and Foundry reserves the right to make changes in design, appearance and construction of any and all products listed herein without incurring any obligation in making such changes in products previously sold or transferred. We reserve the right to discontinue the availability of any products at such time we deem necessary.



AMERICANFORGE&FOUNDRY™

Category	Product Example	Pages	Category	Product Example	Pages
Floor Jacks		4-7	Engine Cranes		28-29
Axle Jacks		8-9	Engine Stands		30-31
Multi Stage Jacks		10-11	Shop Presses		32-35
Long Chassis Jacks		12-13	Stands		36-38
Air Lifts		14	Material Handling		39-41
Transmission Jacks		16-19	Lubrication		42-50
Clutch Jacks		20-21	Shop Equipment		15, 51-57
Bottle Jacks		22-23	Viking Brand		58-59
Collision Repair		24-27	Displays		60-61



AFF JACKS are designed to meet the diverse lifting needs of the professional service technician. Each unit has tough heavy gauge, flanged side plates for added strength and stability and is UV powder coated for added durability. All units have a safety overload valve for added protection. There is also a line of jacks to meet the lifting needs required for low profile "Tuner" and high performance vehicles.

3-1/2 TON PROFESSIONAL HEAVY-DUTY FLOOR JACK
MODEL 350GT

The Heavy Duty standard for tire and service shops!

- Lifts from 4" to 19-1/2"
- Pinned steel saddle (1-1/8" stud) with rubber pad for added vehicle protection
- Rear-mounted 2-3/4" swivel casters for ease of maneuverability
- High strength steel yoke
- One-piece 50-1/4" padded handle parks upright
- Extra wide front casters for superior stability
- Safety valve prevents overload
- Flanged side plates for increased strength and stability
- Universal joint technology for precision control of release valve
- Tough powder coated frame for longer shop life



MODEL	CAPACITY (tons)	LOW HEIGHT	HIGH HEIGHT	CHASSIS LENGTH	OVERALL WIDTH (front)	OVERALL WIDTH (rear)	SHIP WEIGHT
350GT	3-1/2	4"	19-1/2"	29"	11-1/4"	15"	117 lbs.

3-1/2 TON PROFESSIONAL HEAVY-DUTY DOUBLE-PUMPER FLOOR JACK
MODEL 350SS

This unit offers all the features of our Model 350GT with additional speed and efficiency thanks to AFF's double-pumper advantage for quicker lifting.

- Lifts from 4" to 19-1/2"
- Pinned steel saddle (1-1/8" stud) with rubber pad for added vehicle protection
- Rear mounted 2-3/4" swivel casters for ease of maneuverability
- One piece 50-1/4" padded handle parks upright
- Equipped with a double pump design to increase speed without compromising overall performance of the jack
- Second volume pump assists in getting the saddle to load much quicker than most other single pump designs on the market today

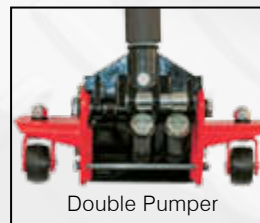

MODEL	CAPACITY (tons)	LOW HEIGHT	HIGH HEIGHT	CHASSIS LENGTH	OVERALL WIDTH (front)	OVERALL WIDTH (rear)	SHIP WEIGHT
350SS	3-1/2	4"	19-1/2"	29"	11-1/4"	15"	119 lbs.



2-TON LOW-RIDER FLOOR JACK

MODEL 200T

Built with traditional AFF quality, perfect for today's lower-profile vehicles. The 200T quickly lifts from a low 2-3/4" to 20" with AFF's double-pumper advantage

- Super low pickup height of 2-3/4"
- Equipped with a double pump design to increase speed without compromising performance.
- Universal joint technology and precision release valve for a more controlled release
- Pinned steel saddle (1" stud) with rubber pad for added vehicle protection and durability
- Tough UV powder coated frame for greater protection and durability
- One-piece foam covered 50" handle for ease of positioning, pumping and storage.
- Safety valve prevents overload

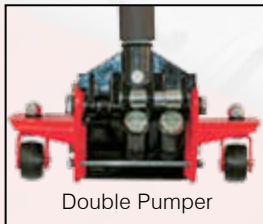

Double Pumper



MODEL	CAPACITY (tons)	LOW HEIGHT	HIGH HEIGHT	CHASSIS LENGTH	OVERALL WIDTH (front)	OVERALL WIDTH (rear)	SHIP WEIGHT
200T	2	2-3/4"	20"	27"	11-3/4"	15"	99 lbs.

2-TON PROFESSIONAL ALUMINUM RACING JACK

MODEL 200SS

Dependability and quality are provided in this super-lightweight professional jack. The added advantage of our double-pumper technology (see inset) provides rapid lifting efficiency, and it only weighs 54 lbs.

- Lifts from 3-3/4" to 19-1/2"
- Unique single-piece removable handle
- Durable anodized finish
- Pinned saddle with rubber pad for added vehicle protection
- Chrome coilover return springs
- Nylon wheels and casters
- Side handles for easier transporting
- Wide stance for added stability
- Large side reservoirs with increased oil capacity for speed and smoothness.

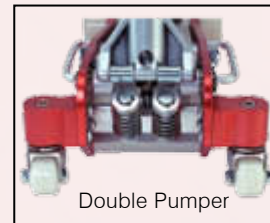

Double Pumper



MODEL	CAPACITY (tons)	LOW HEIGHT	HIGH HEIGHT	CHASSIS LENGTH	OVERALL WIDTH (front)	OVERALL WIDTH (rear)	SHIP WEIGHT
200SS	2	3-3/4"	19-1/2"	26"	11-3/4"	13"	54 lbs.

AFF Specialty Floor Jacks are designed for applications where added reach and/or height are required. Each unit is designed with our heavy gauge steel frames and are powder coated for added protection.

2-1/4 TON CAPACITY BODY SHOP JACK

MODEL 2110A

- Ideal for use in body shop applications, when loading vehicles onto frame straightening equipment.
- Long 47" handle
- Two 3-1/2" steel wheels in front and two 2-1/4" steel rear casters
- Foot pedal equipped for fast saddle to lifting point
- Super 32" high lift



MODEL	CAPACITY (tons)	LOW HEIGHT	HIGH HEIGHT	CHASSIS LENGTH	OVERALL WIDTH (front)	OVERALL WIDTH (rear)	SHIP WEIGHT
2110A	2-1/4	5-3/4"	32"	48"	11-1/2"	17-1/2"	135 lbs.

7-TON FORKLIFT JACK

MODEL 3917

The scissor jack point is low enough to efficiently access and lift a variety of popular forklift models.

- Scissors lift from 2-1/2" to 16-1/2"
- 14" reach in raised position
- Safety valve provides critical overload protection
- Rugged wheels make load alignment easier
- Chassis 26" long x 9" wide



MODEL	CAPACITY (tons)	LOW HEIGHT	HIGH HEIGHT	REACH	WIDTH	SHIP WEIGHT
3917	7	2-1/2"	16-1/2"	14"	9-7/8"	150 lbs.



Floor Jack Accessories

750 LB. CAPACITY TRANSMISSION ADAPTER HEAD MODEL 3165

Converts any AFF 350 series or Viking floor jack (or others with a 1-1/8" saddle stud) to remove and install automobile transmissions, transfer cases and differentials.

- Saddle is 19-1/2" wide
- 30° front tilt and 15° back tilt.
- Ship weight 28 lbs.



CROSSBEAM ADAPTER MODEL 3167

Use any AFF or Viking floor jacks with a 1/1-8" diameter saddle stud to lift the entire front or rear of a vehicle.

- 4,400 lb. capacity
- Two telescopic 4-3/4" x 4-3/4" rubber saddle pads for added vehicle protection easily adjust to a maximum 38" width
- Ship weight 31 lbs.



Floor Jack Replacement Parts

REPLACEMENT SADDLE PAD MODEL 200TK42

Fits AFF Model 200T floor jack. Ship weight 1 lb.

REPLACEMENT SADDLE PAD MODEL 200SSK43

Fits AFF Model 200SS racing jack. Ship weight 2 lbs.

REPLACEMENT SADDLE PAD MODEL 350GTK41

Fits AFF Model 350GT & 350SS floor jacks. Ship weight 1 lb.

AFF JACK HANDLE BUMPER MODEL 390

- Protects vehicle from dings and scrapes if jack handle accidentally falls against car.
- Fits 200T, 3003, 350 Series & most 2" handles.
- "Tight-fit" design keeps handle pad firmly in place.
- Made of solvent resistant high impact plastic.
- Air filled end cap provides additional impact protection.
- Inexpensive insurance for car finishes.
- Works on many other shop tools such as tire tools, bead breakers, press handles, etc.
- Ship weight 1 lb.

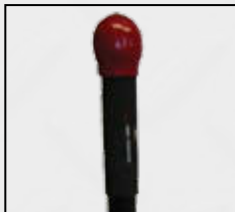

REPLACEMENT FOAM HANDLE COVER MODEL 350GTK23

Fits all AFF Model 350 series floor jacks. Ship weight 7 lbs.

REPLACEMENT FOAM HANDLE COVER MODEL 200TK40

Fits AFF Model 200T floor jack. Ship weight 7 lbs.

ONE PIECE HANDLE MODEL 350SSK24

Fits AFF Model 200T, 350GT & 350SS floor jacks. Ship weight 8 lbs.

POLYURETHANE WHEEL KIT MODEL 35014P

Designed to make AFF Model 350GT and 350SS floor jacks for use on tile, epoxy or sealed floors. Kit includes two front wheels and two rear casters that are easily installed to protect special floor surfaces. Ship weight 7 lbs.



AFF Air/Hydraulic Axle Jacks are designed and built to withstand the extreme conditions of every day use in heavy duty applications, including roadside service, fleet maintenance, off road vehicle service and much more.

SUPER DUTY 22-TON AIR/HYDRAULIC AXLE JACK

MODEL 522SD

- America's premium quality 22 Ton axle jack
- This super duty work horse features a specially heat treated cylinder wall and chrome piston machined to super exacting tolerances ensuring premium performance, durability, life and safety
- Premium air motor lasts longer and is more reliable than competitive brands
- Safety valve prevents damage from overload
- Large diameter wheels assist in maneuverability
- Long "T" handle with integrated release assists in jack positioning
- Handle lock allows the handle to be secured in the vertical, 45° or horizontal positions
- Our new heavy duty 22 Ton axle jack offers outstanding durability and quality
- Ships in two cartons



3 pc. adaptor kit included as standard accessory

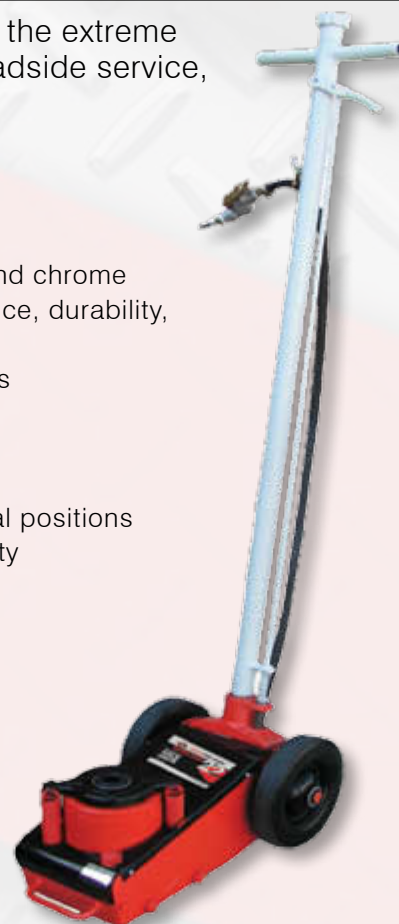

MODEL	CAPACITY (tons)	RAM LIFT	LOW HEIGHT	HIGH HEIGHT	LENGTH	SHIP WEIGHT
522SD	22	4-3/4"	8"	17"	20-1/8"	100 lbs.

44-TON AIR/HYDRAULIC AXLE JACK

MODEL 544

- AFF's largest capacity air / hydraulic single stage truck jack
- Outstanding durability and quality
- 41" one piece "T" handle
- Large rubber tires for easy movement
- Heat treated cylinder wall to protect against scoring
- Operates at 90 - 180 PSI
- Easily handles full load roadside truck changes, agricultural equipment, heavy construction, bus and military applications



3-PC EXTENSION KIT (sold separate)

MODEL 544EXT

- Includes 1-2/16", 2-3/4" & 4-5/16" ram extensions for AFF Model 544.
- Ship weight 12 lbs.



MODEL	CAPACITY (tons)	RAM LIFT	LOW HEIGHT	HIGH HEIGHT	REACH	WIDTH	SHIP WEIGHT
544	44	4"	9-1/4"	16-1/4"	64"	19"	145 lbs.



22-TON AXLE JACK (2-pc. handle)
MODEL 565E

22-TON AXLE JACK (1-pc. handle)
MODEL 565E1

- Heat treated cylinder wall & chromed piston give added stability & longer jack life
- Alloy steel lifting mechanism for added durability and operator safety
- Precision engineered tolerances for maximum performance
- In-line filter to protect air motor from contaminants
- Corrosion-resistant aluminum and nylon composite air motor
- Ram extension kit included with 3/4", 2-3/4" and 4" extensions
- Large 7-3/4" rear wheels for easy positioning
- Automatic in-line oiler to lubricate air motor
- Grommet retainers-no need for clevis pins

ONE-PIECE "T" HANDLE
MODEL 565E-HANDLE

Ship weight 14 lbs.

Includes 3 pc. adaptor set, storage bracket with grommet retainers



MODEL	CAPACITY (tons)	RAM LIFT	LOW HEIGHT	HIGH HEIGHT	REACH	WIDTH	SHIP WEIGHT
565E	22	4-3/4"	8-3/4"	21-1/2"	61"	13"	107 lbs.
565E1	22	4-3/4"	8-3/4"	21-1/2"	61"	13"	107 lbs.

35-TON AIR/HYDRAULIC AXLE JACK
MODEL 535A

Designed for heavy-duty use in lifting trucks, buses, trailers or other heavy-duty equipment. AFF's Model 535A is compact, easy to maneuver and highly efficient. Large polyurethane wheels for durability and easy positioning.

- Lifts up to 21-1/4" with screw extension
- 55" long for hard-to-reach lift points under vehicles with long overhangs
- Can be operated with air (90-180 PSI) or manually
- Large wheels allow for easy positioning of jack under load.
- Unique design allows for vertical storage of jack when not in use
- Built-in safety valve prevents jack from being used beyond its capacity



MODEL	CAPACITY (tons)	RAM LIFT	LOW HEIGHT	HIGH HEIGHT	REACH	WIDTH	SHIP WEIGHT
535A	35	5-3/4"	11"	21-1/4"	55"	8"	101 lbs.



AFF Multi-Stage Jacks are Super Heavy Duty air/hydraulic jacks built tough for the rigors of Trucking, Agricultural and Fleet business. The piston head design is borrowed from industrial technology, providing a superior low and high pressure seal, which gives these jacks a much better hold under severe load conditions. An integral Descent Metering Valve maintains a controlled and safe lowering of the load. Double polished chromed pistons allow for much tighter tolerances which reduce oil bypassing and reduced ram scoring. Built in overload safety valves prevent damage to unit due to excessive load. Air assisted lowering speeds up ram retraction.

**30/15 TON TWO STAGE AIR/HYDRAULIC AXLE JACK
MODEL 545SD**



- The extra light weight and portability makes this the ideal service jack for Service Vehicles
- 2 Stages and lifting capacities of 30 and 15 Ton make this a very versatile jack.
- The extra long removable handle and rugged rear wheels make for easy positioning in hard to reach places.
- Air assisted lowering speeds up ram retraction
- Comes with 2 extensions (75mm/3" + 45 mm/1.75") and saddle adapter
- Units are tested to -13F(-25C) and +113F(+45C) as well as off center loading to ensure a long life under the harshest conditions
- Low height makes this one of the lowest operating heavy jacks on the market.
- Ideally suited for drop axles and other low clearance jobs.



Shown with 2-pc. extension kit installed

MODEL	CAPACITY (tons)	RAM LIFT	LOW HEIGHT	HIGH HEIGHT	HIGH HEIGHT With Extensions	WORKING AIR PRESSURE	SHIP WEIGHT
545SD	30	2.91"	5.92"	8.82"	14.57"	116 to 145 PSI	77 lbs.
	15	5.59"	5.92"	11.5"	17.25"		

**25/10 TON TWO STAGE AIR/HYDRAULIC AXLE JACK
MODEL 546SD**



- SUPER HEAVY DUTY, 2 Stage 25 Ton and 10 Ton
- The extra long 138cm (54") handle can be locked in 2 positions for easy positioning in hard to reach places.
- Single piece base construction provides superior strength for increased load stability
- Air assisted lowering speeds up ram retraction
- Comes with 2 extensions (75mm/3" + 45 mm/1.75") and saddle adapter
- Units are tested to -13F(-25C) and +113F(+45C) as well as off center loading to ensure a long life under even the harshest conditions



MODEL	CAPACITY (tons)	RAM LIFT	LOW HEIGHT	HIGH HEIGHT	HIGH HEIGHT With Extensions	WORKING AIR PRESSURE	SHIP WEIGHT
546SD	25	3.82"	7.28"	11.10"	16.85"	116 to 174 PSI	128 lbs.
	10	7.56"	7.28"	14.84"	20.59"		



50/25 TON TWO STAGE AIR/HYDRAULIC AXLE JACK

MODEL 547SD

- SUPER HEAVY DUTY 2 Stage 50 Ton and 25 Ton
- The extra long 138cm (54") handle can be locked in 3 positions for easy positioning of this jack in hard to reach places.
- Single piece base construction provides superior strength for increased load stability
- Air assisted lowering speeds up ram retraction
- Comes with 2 extensions (75mm/3" + 45 mm/1.75") and saddle adapter



MODEL	CAPACITY (tons)	RAM LIFT	LOW HEIGHT	HIGH HEIGHT	HIGH HEIGHT With Extensions	WORKING AIR PRESSURE	SHIP WEIGHT
547SD	50	4.61"	8.46"	13.07"	18.82"	116 to 174 PSI	165 lbs.
	25	9.09"	8.46"	17.56"	23.31"		

60/40/20 TON THREE STAGE AIR/HYDRAULIC AXLE JACK

MODEL 548SD

- SUPER HEAVY DUTY 3 Stage 60 Ton, 40 Ton and 20 Ton
- The extra long 138cm (54") handle can be locked in 3 positions for easy positioning of this jack in hard to reach places.
- Single piece base construction provides superior strength for increased load stability
- Comes with 2 extensions (75mm/3" + 45 mm/1.75") and saddle adapter



MODEL	CAPACITY (tons)	RAM LIFT	LOW HEIGHT	HIGH HEIGHT	HIGH HEIGHT With Extensions	WORKING AIR PRESSURE	SHIP WEIGHT
548SD	60	3.03"	6.89"	9.92"	15.67"	116 to 174 PSI	165 lbs.
	40	5.79"	6.89"	12.68"	18.43"		
	20	9.02"	6.89"	15.91"	21.66"		

80/50 TON TWO STAGE AIR/HYDRAULIC AXLE JACK

MODEL 549SD

- SUPER HEAVY DUTY 2 Stage 80 Ton and 50 Ton
- The extra long 138cm (54") handle can be locked in 3 positions for easy positioning of this jack in hard to reach places.
- An integral Descent Metering Valve maintains a controlled and safe lowering of the load
- Single piece base construction provides superior strength for increased load stability
- Air assisted lowering speeds up ram retraction
- Comes with 2 extensions (75mm/3" + 46 mm/1.75") and saddle adapter



MODEL	CAPACITY (tons)	RAM LIFT	LOW HEIGHT	HIGH HEIGHT	HIGH HEIGHT With Extensions	WORKING AIR PRESSURE	SHIP WEIGHT
549SD	80	3.03"	9.06"	13.39"	19.14"	116 to 174 PSI	240 lbs.
	50	5.79"	9.06"	17.32"	23.07"		



AFF Long-Chassis Floor Jacks are designed for heavy-duty lifting applications (such as bus and truck fleets, agricultural, industrial and heavy construction equipment) requiring access to very low hard-to-reach areas. All models include foot-operated pumps for quicker lifting efficiency, automatic overload safety valves and swivel casters for ease of maneuverability in tight shop situations. A handle-mounted control lever to lock handle in one of three positions (for more convenient under-vehicle positioning) and ease to operate the release. All AFF air-assisted floor jacks can be operated manually when shop air is not available.

5-TON CAPACITY HEAVY-DUTY LONG-CHASSIS JACK

MODEL 3120

Designed for heavy-duty lifting applications (such as bus and truck fleets, agricultural, industrial and heavy construction equipment) requiring access to very low hard-to-reach areas

- Long 56" body for easier lifting of vehicle with long overhangs
- Foot-operated pump for quick lifting efficiency
- Automatic overload safety valves
- Swivel casters for ease of maneuverability in tight shop situations
- A handle-mounted control lever to lock handle in 1 of 3 positions



MODEL	CAPACITY (tons)	LOW HEIGHT	HIGH HEIGHT	LENGTH	FRONT WIDTH	REAR WIDTH	SHIP WEIGHT
3120	5	6"	22-1/2"	56"	11-1/2"	15"	254 lbs.

5-TON CAPACITY HEAVY-DUTY AIR/HYDRAULIC LONG-CHASSIS JACK

MODEL 3125

Designed for heavy-duty lifting applications (such as bus and truck fleets, agricultural, industrial and heavy construction equipment) requiring access to very low hard-to-reach areas.

- Operates at 115-200 PSI, 7.8 cubic feet per minute
- Long 56" body
- Foot-operated pump for quick lifting efficiency
- Automatic overload safety valves
- Large, rugged 4-1/2" front wheels and 2-3/4" rear casters
- A handle-mounted control lever to lock handle in 1 of 3 positions
- Can be operated manually when shop air is not available



MODEL	CAPACITY (tons)	LOW HEIGHT	HIGH HEIGHT	LENGTH	FRONT WIDTH	REAR WIDTH	SHIP WEIGHT
3125	5	6"	22-1/2"	56"	11-1/2"	15"	273 lbs.



**10-TON CAPACITY HEAVY-DUTY
LONG-CHASSIS JACK**

MODEL 3130

Designed for heavy-duty lifting applications (such as bus and truck fleets, agricultural, industrial and heavy construction equipment) requiring access to very low hard-to-reach areas.

- Long 61" body for easier lifting of vehicle with long overhangs
- Foot-operated pump for quick lifting efficiency
- Automatic overload safety valves
- Swivel casters for ease of maneuverability in tight shop situations
- A handle-mounted control lever to lock handle in 1 of 3 positions
- Extra-wide stance for additional stability



MODEL	CAPACITY (tons)	LOW HEIGHT	HIGH HEIGHT	LENGTH	FRONT WIDTH	REAR WIDTH	SHIP WEIGHT
3130	10	7"	23"	61"	13"	18"	366 lbs.

**10-TON CAPACITY HEAVY-DUTY
AIR/HYDRAULIC LONG-CHASSIS JACK**

MODEL 3135

Designed for heavy-duty lifting applications (such as bus and truck fleets, agricultural, industrial and heavy construction equipment) requiring access to very low hard-to-reach areas.

- Operates at 115-200 PSI, 7.8 cubic feet per minute
- Long 61" body with 8-1/4" frame height for easier lifting of vehicles with long overhangs
- Foot-operated pump for quick lifting efficiency
- Automatic overload safety valves
- Large, rugged 4-1/2" front wheels and 2-3/4" rear casters
- A handle-mounted control lever to lock handle in 1 of 3 positions
- Can be operated manually when shop air is not available



MODEL	CAPACITY (tons)	LOW HEIGHT	HIGH HEIGHT	LENGTH	FRONT WIDTH	REAR WIDTH	SHIP WEIGHT
3135	10	7"	23"	61"	13"	18"	387 lbs.

**20-TON CAPACITY HEAVY DUTY HYDRAULIC
LONG-CHASSIS SERVICE JACK**

MODEL 3140

Designed for heavy-duty lifting applications (such as bus and truck fleets, agricultural, industrial and heavy construction equipment) requiring access to very low hard-to-reach areas.

- Long 67" body for easier lifting of vehicles with long overhangs
- Dual steel front wheels for added security & durability
- Automatic overload safety valves
- A handle-mounted control lever to lock handle in 1 of 3 positions



MODEL	CAPACITY (tons)	LOW HEIGHT	HIGH HEIGHT	LENGTH	FRONT WIDTH	REAR WIDTH	SHIP WEIGHT
3140	20	7-3/4"	23-3/4"	67"	14-1/2"	19-5/8"	450 lbs.



AFF Air Lift Jacks are designed to efficiently lift large trucks, trailers, buses, heavy-duty construction equipment and agricultural vehicles. They function on 100% air for dependability and longevity.

10-TON AIR LIFT JACK

MODEL 3400A

This Air Lift Jack is designed for lifting and supporting trailers, large trucks, buses, farm, industrial, and construction equipment.

- 10-ton capacity achieved at 200-PSI air supply
- Heavy-duty air valve offers accurate lift control
- Removable "T" handle for easy storage
- Extension tubes offer multiple lifting and locking positions
- 12" Lift travel
- Large diameter rubber tread wheels



MODEL	CAPACITY (tons)	LOW HEIGHT	HIGH HEIGHT	LENGTH	BASE WIDTH	OVERALL HEIGHT	SHIP WEIGHT
3400A	10	18"	52"	27"	12-3/4"	18-1/4"	172 lbs.

5-1/2 TON LONG-REACH AIR END LIFT

MODEL 3596

Designed for heavy-duty low-profile vehicles that require a longer reach in order to be securely lifted at the vehicle front axle or frame and can also be used on the bumper. The scissor action design and full shop air operation (160 PSI) provide more lift height under low profile vehicles. Using its multiple saddle sizes and adjustments along with its standard drop-axle adapter it can lift from as low as 6-1/2" to a high 53-1/2" with a long 48" forward reach.

- Steel saddles adjust between 23" & 45" widths to accommodate a variety of vehicle applications
- 48" forward reach (distance from cylinder to saddles)
- Two saddle sizes and drop axle adapter increase versatility
- Three-way heavy-duty air valve for precision lifting
- Automatic safety lock engages in five preset positions
- Two large pneumatic wheels for easy maneuverability



Adapters



MODEL	CAPACITY (tons)	LOW HEIGHT	HIGH HEIGHT	LENGTH	BASE WIDTH	OVERALL HEIGHT	SHIP WEIGHT
3596	5-1/2	6-1/2"	53-1/2"	77"	23"	70"	638 lbs.

10-TON AIR END LIFT

MODEL 3598

The AFF Air End Lift is designed with an extra-wide stance to lift the entire front or rear of large trucks, buses, industrial, heavy-duty construction equipment, and large farm vehicles.

- 10-Ton capacity achieved at 200-PSI air supply
- 4" x 6" steel saddles adjust between 36" and 50" widths
- Saddle arms reversible for low height loads
- Three-way air valve for fine lifting and lowering control
- Automatic mechanical safety lock engages at five lift heights from 17-1/2" to 50"
- Two air control valve fittings – one for shop air supply and one for a Schrader valve
- Front swivel caster and two pneumatic rear tires for easy maneuverability
- 13" Forward reach (distance from cylinder to saddles)



MODEL	CAPACITY (tons)	LOW HEIGHT	HIGH HEIGHT	LENGTH	BASE WIDTH	OVERALL HEIGHT	SHIP WEIGHT
3598	10	12-1/2"	50"	39"	36"	67"	750 lbs.



3/4-TON CAPACITY HEAVY-DUTY WHEEL DOLLY MODEL 3577

Used to facilitate the efficient removal, installation and transport of single, or dual truck wheel assemblies.

- Lift arms adjust inward and outward to handle different wheel combinations
- Provides extra low access to easily position heavy wheel assemblies
- Leveling screw for precise alignment
- Full 7-3/4" ram lift
- Six-foot safety chain secures wheels in place during removal and transport
- 3 large swivel casters



MODEL	LOW HEIGHT	HIGH HEIGHT	LENGTH	WIDTH	SHIP WEIGHT
3577	2-1/2"	10-1/4"	31"	43"	166 lbs.

BRAKE DRUM HANDLER MODEL 3595A

- Efficiently install, remove and transport 15" to 16-1/2" brake drums
- Heavy-duty steel construction
- Height adjustable rotary handle
- Adjustable brackets secure inboard and outboard drums with disc wheel hubs
- Removable rotating handle
- Ship weight 55 lbs.



PORTABLE TRUCK WHEEL DOLLY MODEL 3590A

Designed for "one-technician operation" reducing repair labor costs. Ideal for road service applications.

- 300 lb. capacity
- Rugged tubular steel construction
- Handles wheels up to 24" diameter
- 8" rollers turn and pivot for accurate and efficient alignment of mounted truck tires with hub studs
- Ship weight 18 lbs.

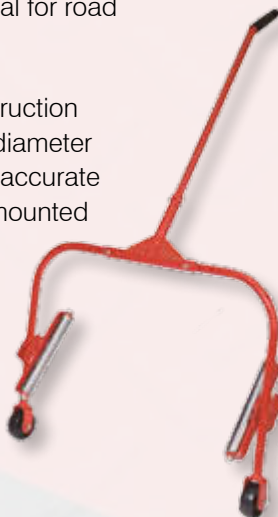

SUPER SINGLE WHEEL DOLLY MODEL 3591

- Easily handles new super wide tires that are becoming prevalent in the trucking industry.
- Provides technician with the leverage needed to handle the removal and installation of large tires
- Heavy duty tubular steel construction
- Bent handle design improves leverage and reduces user strain
- 14" rollers turn and pivot for accurate & efficient alignment of mounted truck tires with hub studs
- 26" wide carriage handles tire diameters 36" - 48"
- 450 lb. capacity
- Ship weight 25 lbs.

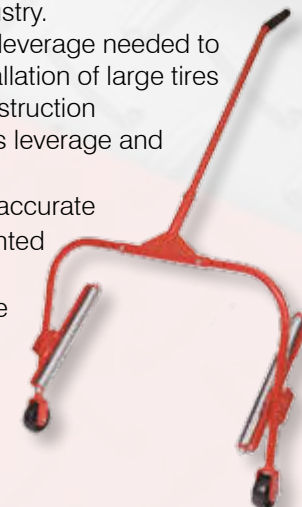

HEAVY-DUTY TRUCK WHEEL STEP MODEL 3912A

- Truck step wraps over tire, providing a nonslip step for loading roof racks and servicing trucks, SUV's and semis.
- Fits truck tires up to 24-1/2" diameter.
- 9" x 27" step with rugged non-slip tread.
- Heavy duty quality
- Folds flat for storage
- Specification
- Capacity: 300 lbs.
- 26-1/2" L x 9-1/2" W
- Nonskid Surface
- Ship Wt: 17.5 lbs



AUTOMOTIVE/LIGHT TRUCK WHEEL STEP MODEL 3911A

- Adjustable Automotive / Light Truck step wraps over tire, providing a nonslip step for loading roof racks and servicing trucks, and SUV's.
- Heavy duty quality
- Adjusts to tire depth and height
- Folds flat for storage
- Specification
- Capacity: 300 lbs.
- 21" L x 7" W
- Nonskid Surface
- Ship weight: 14 lbs



**2-Stage
Air-Assist Jacks**

AFF Hydraulic Telescopic Transmission Jacks provide service technicians one-man capabilities for installing transmissions, differentials or transfer cases. Capacities range between 700 lbs. and 2200 lbs. for applications from light duty cars to mid-size trucks.

**1100 LB. CAPACITY AIR HYDRAULIC TELESCOPIC TRANSMISSION JACK
MODEL 3190SS**

The AFF 1/2 Ton capacity Air/Hydraulic Transmission Jack combines an air-operated first stage for maximum speed with a hydraulic second stage for more accurate final positioning.

- Four fast-ratcheting head brackets to easily secure to transmission pan flanges.
- Extendable height from 34" to 72-3/4"
- Large crank handles for precise head adjustments
- Strong nylon safety strap for secure load anchoring
- Solid (41" x 41") stance with heavy-duty, wide 4" swivel casters for easier, more efficient under-hoist positioning



MODEL	CAPACITY (lbs)	RAM STAGES	LOW HEIGHT	HIGH HEIGHT	FRONT TILT	REAR TILT	SIDE TILT	HEAD WIDTH	HEAD LENGTH	BASE WIDTH	SHIP WEIGHT
3190SS	1100	2	34"	72-3/4"	50°	20°	10°	8-1/2"-19-1/2"	8-1/2"-19-1/2"	41"x41"	220 lbs.

**1100 LB. CAPACITY AIR/HYDRAULIC TELESCOPIC TRANSMISSION JACK
MODEL 3192A**

Air or manual foot operated, two-stage ram frees both hands for easier alignment of automotive, van, and light truck transmissions, transfer cases or differentials in under hoist applications.

- Universal head provides forward, back and side tilt
- Fully-adjustable universal saddle with spring-loaded corner brackets for easy "tool-free" adjustment
- 90-120 PSI air pressure required; 7-7/8 cu. ft./min. air consumption
- Use this jack to remove and install fuel tanks by ordering AFF Fuel Tank Adapter #3198 (sold separately)



MODEL	CAPACITY (lbs)	RAM STAGES	LOW HEIGHT	HIGH HEIGHT	FRONT TILT	REAR TILT	SIDE TILT	HEAD WIDTH	HEAD LENGTH	BASE WIDTH	SHIP WEIGHT
3192A	1100	2	38"	73-1/2"	42°	46°	2°	7"- 22"	9"- 20"	38"x 38"	218 lbs.

**Single Stage
Manual Jacks**

**1100 LB. CAPACITY TELESCOPIC TRANSMISSION JACK
MODEL 2158**

Single-stage telescopic ram for use on automobile, light truck and van transmissions, transfer cases or differentials in under-hoist applications.

- Universal head provides forward and back tilt
- Wide base for maximum stability
- Foot-operated pump frees both hands for easier saddle-to-transmission alignment
- Convenient release knob



MODEL	CAPACITY (lbs)	RAM STAGES	LOW HEIGHT	HIGH HEIGHT	FRONT TILT	REAR TILT	SIDE TILT	HEAD WIDTH	HEAD LENGTH	BASE WIDTH	SHIP WEIGHT
2158	1100	1	45"	71"	30°	15°	NA	8"-14"	14"	23"x23"	103 lbs.



2-Stage Manual Jacks

2200 LB. CAPACITY TELESCOPIC TRANSMISSION JACK

MODEL 2195A

Two-stage telescopic ram, designed for heavier automotive and medium-duty truck transmissions, transfer cases or differentials in under-hoist applications.

- Universal head provides forward, back and side tilt
- Automatic safety valve provides critical overload protection
- Adjustable saddle with corner brackets and safety chain
- Use this jack to remove and install fuel tanks by ordering AFF Fuel Tank Adapter #3198 (sold separately)



MODEL	CAPACITY (lbs)	RAM STAGES	LOW HEIGHT	HIGH HEIGHT	FRONT TILT	REAR TILT	SIDE TILT	HEAD WIDTH	HEAD LENGTH	BASE WIDTH	SHIP WEIGHT
2195A	2200	2	38"	73-1/2"	30°	15°	12°	10"-14"	14"-18"	44"x44"	237 lbs.

1100 LB. CAPACITY TELESCOPIC TRANSMISSION JACK

MODEL 3190B

2-stage manual hydraulic operation.

- Universal head provides forward, back and side tilt
- Fully adjustable universal saddle with spring-loaded corner brackets for easy "tool-free" adjustment
- Use this jack to remove and install fuel tanks by ordering AFF Fuel Tank Adapter #3198 (sold separately)



MODEL	CAPACITY (lbs)	RAM STAGES	LOW HEIGHT	HIGH HEIGHT	FRONT TILT	REAR TILT	SIDE TILT	HEAD WIDTH	HEAD LENGTH	BASE WIDTH	SHIP WEIGHT
3190B	1100	2	38"	73-1/2"	42°	46°	12°	7"-22"	9"-20"	38"x38"	203 lbs.

Single Stage Manual Jacks

700 LB. CAPACITY TELESCOPIC TRANSMISSION JACK

MODEL 2145

Economical single stage ram for use on automobile transmissions, transfer cases or differentials in under-hoist applications.

- Large 360° swivel casters
- Adjustable saddle
- Replaceable single-stage telescopic ram.
- 700 lbs. capacity
- Single stage ram



MODEL	CAPACITY (lbs)	RAM STAGES	LOW HEIGHT	HIGH HEIGHT	FRONT TILT	REAR TILT	SIDE TILT	HEAD WIDTH	HEAD LENGTH	BASE WIDTH	SHIP WEIGHT
2145	700	1	53"	73"	12°	12°	NA	10"-14"	10"-14"	39"x39"	95 lbs.



4400 LB. CAPACITY HEAVY-DUTY TRANSMISSION JACK

MODEL 3180

AFF has the only super heavy-duty transmission jack with a 4,400 lb. capacity. Built "forge-tough" to handle removal, transport and installation of transmissions, transfer cases or differentials on heavy-duty trucks, buses, agricultural and construction equipment.

- Fully adjustable saddle with maximum tilt for easier alignment
- Adjustable corner brackets
- Convenient side trays for small tools and parts
- Safety overload bypass system to prevent hydraulic damage
- 32" handle pivots 360° around pump
- Rugged industrial-grade 4" casters



MODEL	CAPACITY (lbs)	LOW HEIGHT	HIGH HEIGHT	FRONT TILT	REAR TILT	SIDE TILT	HEAD WIDTH	HEAD LENGTH	WIDTH	LENGTH	SHIP WEIGHT
3180	4400	8-1/2"	34"	15°	30°	12°	12"-18"	16"-20"	26"	43"	374 lbs.

2000 LB. CAPACITY HEAVY-DUTY TRANSMISSION JACK

MODEL 3178

- Designed for heavy truck service
- Adjustable width head plate and wedge shaped brackets allows for a wide range of mounting options and the 4 way tilting head makes for easier removal and installation of the transmission
- Equipped with a 360° swiveling handle for use in tight spots
- Head dimensions: Width - Min. 6-1/2", Max 18-1/4", Length - Min. 6-3/4", Max 18-1/2"
- Open leg design makes it very versatile
- Rugged heavy duty casters
- Safety chain included



MODEL	CAPACITY (lbs)	LOW HEIGHT	HIGH HEIGHT	FRONT TILT	REAR TILT	SIDE TILT	HEAD WIDTH	HEAD LENGTH	WIDTH	LENGTH	SHIP WEIGHT
3178	2000	6-1/2"	31-1/2"	79°	9°	10-18°	18-1/4"	18-1/4"	18-1/2"	37-1/2"	335 lbs.

FUEL TANK ADAPTER

MODEL 3198

Converts AFF Model 3190B, 3192A and 2195A transmission jacks to remove and install fuel tanks.

- 4" x 5-3/4" diameter saddles adjust from 19-3/4" to 31-3/4".
- Includes two safety straps and two grounding cables.
- 80 lb. capacity.
- Ship weight 59 lbs.



1000 LB. CAPACITY TRANSMISSION ADAPTER HEAD

MODEL 3193

This adapter provides maximum flexibility in transforming your transmission jack to remove & install transfer cases or differentials.

- Fully adjustable universal saddle with 42° front, 46° back and 12° side tilt
- Spring-loaded corner brackets.
- Includes safety chains.
- Fits 30mm x 1-1/2" threaded rams.
- Ship weight 52 lbs



Fits all AFF transmission jacks on page 16-17



LOW-PROFILE 2000 LB. CAPACITY TRANSMISSION JACK

MODEL 3172

- Designed for light truck transmissions
- Fully adjustable universal saddle with corner brackets and safety chains
- Safety overload bypass to prevent hydraulic damage
- 24" handle pivots 360° around pump
- Four industrial grade 3" casters



MODEL	CAPACITY (lbs)	LOW HEIGHT	HIGH HEIGHT	FRONT TILT	REAR TILT	SIDE TILT	HEAD WIDTH	HEAD LENGTH	WIDTH	LENGTH	SHIP WEIGHT
3172	2000	5-7/8"	30-3/4"	15°	10°	15°	7"-16"	9"-14"	18-1/4"	36-3/4"	145 lbs.

LOW-PROFILE 1200 LB. CAPACITY TRANSMISSION JACK

MODEL 3171

- Designed for automotive & light truck transmissions
- Fully adjustable universal saddle with corner brackets and safety chains
- Safety overload bypass to prevent hydraulic damage
- 24" handle pivots 360° around pump



MODEL	CAPACITY (lbs)	LOW HEIGHT	HIGH HEIGHT	FRONT TILT	REAR TILT	SIDE TILT	HEAD WIDTH	HEAD LENGTH	WIDTH	LENGTH	SHIP WEIGHT
3171	1200	6-7/8"	31-3/4"	15°	12°	15°	7"-13"	8"-11"	19-3/4"	38-1/4"	117 lbs.

450 LB. CAPACITY TRANSMISSION JACK

MODEL 3160

- Adjustable head for easier positioning and alignment
- Nylon safety strap to secure load
- Requires 1/2" drive ratchet (not included)
- 450 lb. capacity
- Height: 7-1/4" - 22-1/2"
- Ship weight 43 lbs.



TRANSMISSION JACK ADAPTER SET

MODEL 3181

- Ideal for use with AFF's model 3180 Heavy Duty Transmission Jack
- Works with a wide variety of different truck transmissions including Eaton(r) and Fuller(r)
- Comes with 6 adapter bars (4 small, 2 large) 4 positioning screws, and 2 securing chains
- Ship weight 24 lbs.



AFF Clutch Jack with Accessories are designed to assist in all aspects of clutch removal and transport. Accessories include various adapters are available to make the Clutch Jack a "one-man" operation.

CLUTCH JACK

MODEL 3700

- A highly efficient design that provides the technician with capabilities to remove, install and transport heavy duty truck clutches
- This heavy duty unit has a greater capacity than most competitive units and has the added versatility of being able to convert the optional adapters for fly wheels, drive shafts, starter motors, auxiliary cases, differentials, brake drums and camel back springs
- Clutch head assembly turns 360° and pivots side-to-side for efficient clutch/engine alignment
- Two splined alignment shafts (2" OD x 1.18" pilot and 1-3/4" OD x .938" pilot)
- Clutch assemblies can easily be built on the vertical shaft and then positioned easily under the truck
- Pump handle rotates 360° for ease of operation in virtually any work position
- Unique clevis pinned alignment shaft allows technician to remove jack to install clutch assembly without obstruction
- Alignment shafts have "flats" for open end wrench to aid in clutch indexing and internally threaded for slide hammer removal if needed.

MODEL	CAPACITY (lbs)	LOW HEIGHT	HIGH HEIGHT	FRAME DIMENSION	SHIP WEIGHT
3700	500 lbs.	13"	39"	36-1/2" L x 22" W	138 lbs.

All CLUTCH JACK ACCESSORIES shown on the next page (page 21)

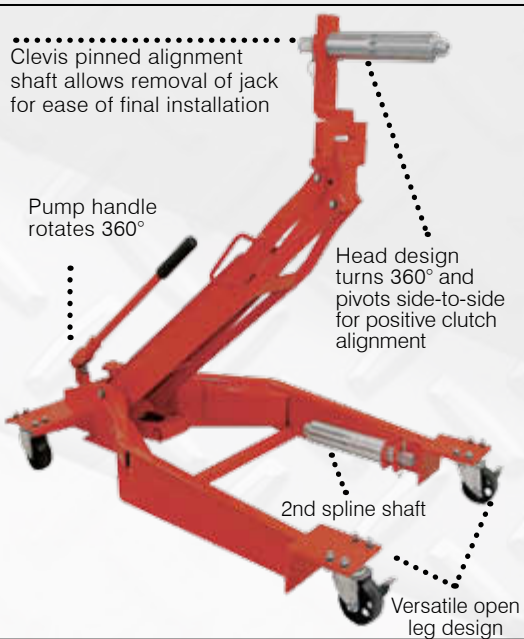
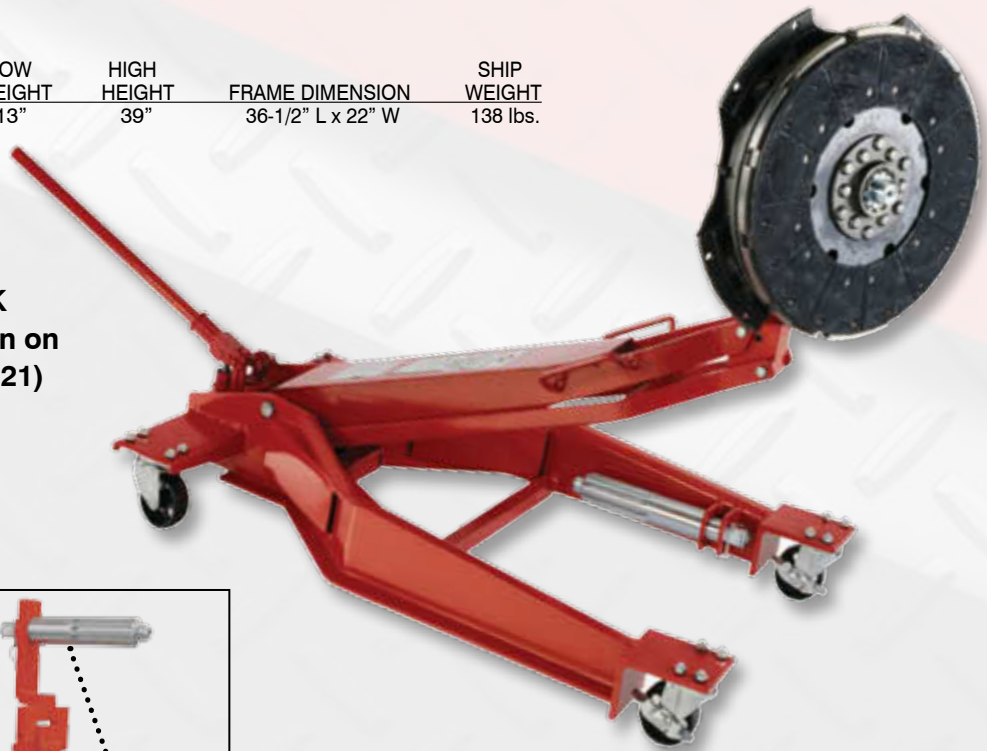

FLYWHEEL ADAPTER

MODEL 3751

Easily replaces the spline and bolts onto flat and pot-style truck flywheels used with 14" and 15-1/2" clutches for more efficient removal and installation.

- Ship weight 6 lbs.



SPLINED SHAFT

MODEL 3749

- 1-3/4" OD x 1.18" Pilot
- Ship weight 6 lbs.

MODEL 3752

- 1-3/4" OD x 0.983" Pilot
- Ship weight 6 lbs.

MODEL 3753

- 2" OD x 1.18" Pilot
- Ship weight 6 lbs.

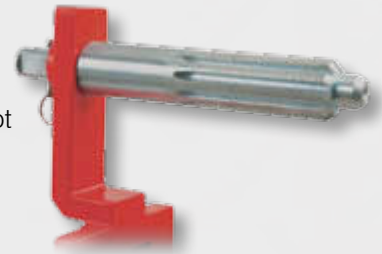

DRIVESHAFT ADAPTER

MODEL 3754

Supports heavy truck driveshafts under the main carrier bearing or the complete shaft, allowing one shop technician to safely move or align them.

- Ship weight 18 lbs.



STARTER MOTOR ADAPTER

MODEL 3755

With its large "V"-shaped surface area, it cradles large truck starter motors and makes their removal, installation and transport easier.

- Ship weight 11 lbs.



AUXILIARY CASE ADAPTER

MODEL 3756

Helps technician remove the auxiliary case without having to remove the complete transmission unit.

- Ship weight 20 lbs.

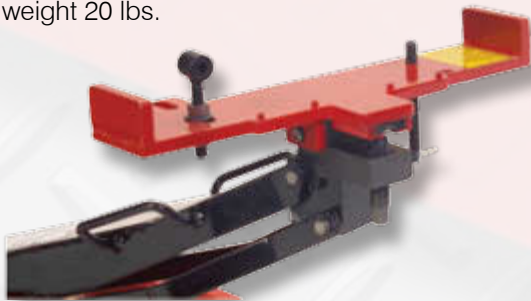

DIFFERENTIAL ADAPTER

MODEL 3757

Makes removing and installing heavy truck differentials easier and safer by eliminating the need for personal heavy lifting by a shop technician.

- Ship weight 30 lbs.



BRAKE DRUM ADAPTER

MODEL 3758

Works like a forklift to handle heavy truck brake drums. Easily positions under the vehicle to safely remove or install the drum. The tilt and pivot abilities of the head allow for a precise brake drum alignment.

- Ship weight 37 lbs.



CAMELBACK SPRING ADAPTER

MODEL 3759

Allows technician to safely and efficiently change many Mack truck style camelback spring units.

- Ship weight 42 lbs.



AFF Bottle Jacks are built "forge-tough" in a wide selection of capacities for automotive, marine, construction, industrial and agricultural applications where the ability to lift, push, spread, bend, press and straighten either horizontally or vertically are essential. All have centered pumps and rams with heat-treated pistons for balance and easy positioning. Their saddles are made of machine hardened steel. All models with capacities of 8 tons or higher have convenient carrying handles while model 3506C comes in a rugged plastic carrying case.

MODEL 3502



Capacity: 2 Tons
 Low Ht: 6-1/4"
 High Ht: 12-3/4"
 Lift: 4"
 Screw Ext: 2-1/2"
 Base: 3-3/4"x 3-3/4"
 Qty per Case: 6
 Case Wt: 36 lbs.

MODEL 3504



Capacity: 4 Tons
 Low Ht: 6-1/2"
 High Ht: 13-1/4"
 Lift: 4-1/4"
 Screw Ext: 2-1/2"
 Base: 4-1/2" x 4"
 Qty per Case: 6
 Case Wt: 52 lbs.

MODEL 3506



Capacity: 6 Tons
 Low Ht: 8"
 High Ht: 16"
 Lift: 5-1/4"
 Screw Ext: 2-3/4"
 Base: 4-1/2"x 4-3/4"
 Qty per Case: 4
 Case Wt: 44 lbs.

MODEL 3506C



Capacity: 6 Tons
 Low Ht: 8"
 High Ht: 16"
 Lift: 5-1/4"
 Screw Ext: 2-3/4"
 Base: 4-1/2"x 4-3/4"
 Qty per Case: 4
 Case Wt: 50 lbs.

Model 3506 with plastic carrying case

MODEL 3508



Capacity: 8 Tons
 Low Ht: 7-3/4"
 High Ht: 15-1/2"
 Lift: 5"
 Screw Ext: 2-3/4"
 Base: 4-3/4" x 5"
 Qty per Case: 4
 Case Wt: 52 lbs.

MODEL 3512



Capacity: 12 Tons
 Low Ht: 8-1/2"
 High Ht: 17"
 Lift: 5-3/4"
 Screw Ext: 2-3/4"
 Base: 5-1/2"x 5-1/4"
 Qty per Case: 4
 Case Wt: 68 lbs.

MODEL 3514



Capacity: 12 Tons
 Low Ht: 7"
 High Ht: 13"
 Lift: 4"
 Screw Ext: 2"
 Base: 5-1/2"x 5-1/4"
 Qty per Case: 4
 Case Wt: 60 lbs.

MODEL 3520



Capacity: 20 Tons
 Low Ht: 9-5/8"
 High Ht: 18-1/4"
 Lift: 6-3/8"
 Screw Ext: 2-1/4"
 Base: 6-3/4"x 6-1/4"
 Qty per Case: 2
 Case Wt: 54 lbs.

MODEL 3522



Capacity: 20 Tons
 Low Ht: 7-3/4"
 High Ht: 14-1/4"
 Lift: 4-1/4"
 Screw Ext: 2-1/4"
 Base: 6-3/4"x 6-1/4"
 Qty per Case: 2
 Case Wt: 50 lbs.

MODEL 3530



Capacity: 30 Tons
 Low Ht: 11"
 High Ht: 18-5/8"
 Lift: 7-5/8"
 Screw Ext: --
 Base: 7" x 7"
 Qty per Case: 2
 Case Wt: 88 lbs.

MODEL 3550



Capacity: 50 Tons
 Low Ht: 12"
 High Ht: 19"
 Lift: 7"
 Screw Ext: --
 Base: 8-1/2" x 7"
 Qty per Case: 1
 Case Wt: 73 lbs.



AFF Bottle Jacks can be used in either vertical or horizontal positions

12-TON CAPACITY AIR/HYDRAULIC BOTTLE JACK MODEL 5512B

- 90-180 PSI
- Factory pre-tested to 150% of rated capacity
- Safety bypass system
- Dual ram return springs.
- Saddles are machine-hardened steel



Capacity: 12 Tons
 Low Ht: 10-1/4"
 High Ht: 19-3/4"
 Lift: 6-3/4"
 Screw Ext: 3"
 Base: 8-1/2"x 5"
 Ship Wt: 30 lbs.

12-TON CAPACITY AIR/HYDRAULIC BOTTLE JACK MODEL 5520B

- 90-180 PSI
- Factory pre-tested to 150% of rated capacity
- Safety bypass system
- Dual ram return springs.
- Saddles are machine-hardened steel



Capacity: 20 Tons
 Low Ht: 10-1/2"
 High Ht: 20"
 Lift: 6-1/4"
 Screw Ext: 3-1/4"
 Base: 9-1/2"x 6-1/2"
 Ship Wt: 38 lbs.

Bottle Jacks



AFF Heavy-Duty Industrial Bottle Jacks set the highest market standards with their premium grade materials and workmanship. Precision welding, CNC machined parts, as well as forged high grade steel and alloys are combined to provide years of trouble-free service in some of the most severe conditions.

MODEL 4502



Capacity: 2 Tons
 Low Ht: 7-1/8"
 High Ht: 13-9/16"
 Lift: 4-1/2"
 Screw Ext: 2"
 Base: 4-5/16"x 2-9/16"
 Qty per Case: 10
 Case Wt: 6 lbs.

MODEL 4503



Capacity: 3 Tons
 Low Ht: 7-1/2"
 High Ht: 14-3/8"
 Lift: 4-1/2"
 Screw Ext: 2-3/8"
 Base: 4-1/2"x 2-13/16"
 Qty per Case: 10
 Case Wt: 6 lbs.

MODEL 4505



Capacity: 5 Tons
 Low Ht: 7-7/8"
 High Ht: 15-3/8"
 Lift: 4-3/4"
 Screw Ext: 2-3/4"
 Base: 5-1/8"x 3"
 Qty per Case: 10
 Case Wt: 8 lbs.

MODEL 4508



Capacity: 8 Tons
 Low Ht: 7-7/8"
 High Ht: 15-3/8"
 Lift: 4-3/4"
 Screw Ext: 2-3/4"
 Base: 6"x3-1/2"
 Qty per Case: 10
 Case Wt: 12 lbs.

MODEL 4512



Capacity: 12-1/2 Tons
 Low Ht: 9-1/2"
 High Ht: 18-1/2"
 Lift: 5-7/8"
 Screw Ext: 3-1/8"
 Base: 6-1/2"x 4-3/16"
 Qty per Case: 3
 Case Wt: 18 lbs.

MODEL 4513



Capacity: 12-1/2 Tons
 Low Ht: 6-3/4"
 High Ht: 13-3/8"
 Lift: 3-3/4"
 Screw Ext: 3"
 Base: 6-1/2"x 4-3/16"
 Qty per Case: 3
 Case Wt: 14 lbs.

MODEL 4522



Capacity: 22-1/2 Tons
 Low Ht: 10-5/8"
 High Ht: 16-5/16"
 Lift: 6-1/4"
 Screw Ext: --
 Base: 7-3/16 x 5-1/16"
 Qty per Case: 3
 Case Wt: 27 lbs.

MODEL 4523



Capacity: 22-1/2 Tons
 Low Ht: 7-1/8"
 High Ht: 12"
 Lift: 3-3/8"
 Screw Ext: 1-9/16"
 Base: 7-3/16" x 5-1/16"
 Qty per Case: 3
 Case Wt: 22 lbs.

MODEL 4535



Capacity: 35 Tons
 Low Ht: 11"
 High Ht: 17-5/16"
 Lift: 6-1/4"
 Screw Ext: --
 Base: 7-9/16"x 5-9/16"
 Qty per Case: 1
 Case Wt: 41 lbs.

MODEL 4560



Capacity: 60 Tons
 Low Ht: 12"
 High Ht: 18-11/16"
 Lift: 6-3/4"
 Screw Ext: --
 Base: 9-5/16"x 7-3/8"
 Qty per Case: 1
 Case Wt: 82 lbs.

MODEL 4599



Capacity: 100 Tons
 Low Ht: 12"
 High Ht: 17-1/4"
 Lift: 5-1/4"
 Screw Ext: --
 Base: 15-1/2"x 12-1/2"
 Qty per Case: 1
 Case Wt: 207 lbs.



AFF Bottle Jacks can be used in either vertical or horizontal positions

INDUSTRIAL BOTTLE JACKS

- Precision electrically welded steel uni-body
- Can be used in upright, horizontal or angled position
- Machine-hardened needle release valve for precise controlled ram lowering
- Safety overload valves on 4535, 4560 and 4599
- Leak proof casing, cylinder, and base
- Used for lifting, pushing, spreading, bending, pressing or straightening applications
- Withstands temperature extremes
- Carrying handles on 4512, 4513, 4522, 4523, 4535, 4560 and 4599
- Grooved saddles help prevent load slippage
- Chrome plated piston rods for added corrosion resistance

Bottle Jacks



AFF 4 Ton, 10 Ton, and 20 Ton Body and Frame Repair Kits are typically used in vehicle maintenance and collision repair facilities. Kit attachments are interchangeable with most major brands. Models 814, 815 and 818SD come in a rugged metal carrying cases while Models 814C and 815C are packed in a strong, durable plastic case. AFF also offers a variety of Pull Kits for body shop use.

20-TON COLLISION REPAIR KIT

MODEL 818SD

- 20 Ton deluxe collision repair kit used in the trucking, farm and construction industry.
- 2 speed 10,000 PSI pump with safety overload extends the ram to load quickly.
- 20 Ton ram with 5" stroke
- All components use a threaded connection for added strength and durability
- 5' Flexible hose comes with spring guards at both ends
- Comes with 2 metal carry boxes for added mobility and accessibility
- Ship weight 108 lbs.



Each kit includes:

- 2 Speed Hydraulic Hand Pump
- 5' Hydraulic Hose
- 20 Ton Ram w/5" stroke
- 27.5" Extension Tube
- 20" Extension Tube
- 10" Extension Tube
- 5" Extension Tube
- Lock Pin
- Male Connector (3)
- Threaded Coupling (3)
- Plunger Base (2)
- Toe Lift
- Vee Head
- Wedge Head
- Serrated Saddle
- Metal Carry Case (2)



20-TON HYDRAULIC RAM FOR 818SD

MODEL 818SD-41

- Threaded 20 ton ram with 5" stroke
- Direct replacement for ram in the 818SD kit
- Ship weight 30 lbs.

HYDRAULIC PUMP FOR 818SD KIT

MODEL 818SD-40

- 2 speed 10,000 psi pump with safety overload protection
- Same unit as pump included in the 818SD kit
- Ship weight 18 lbs.

Collision Repair



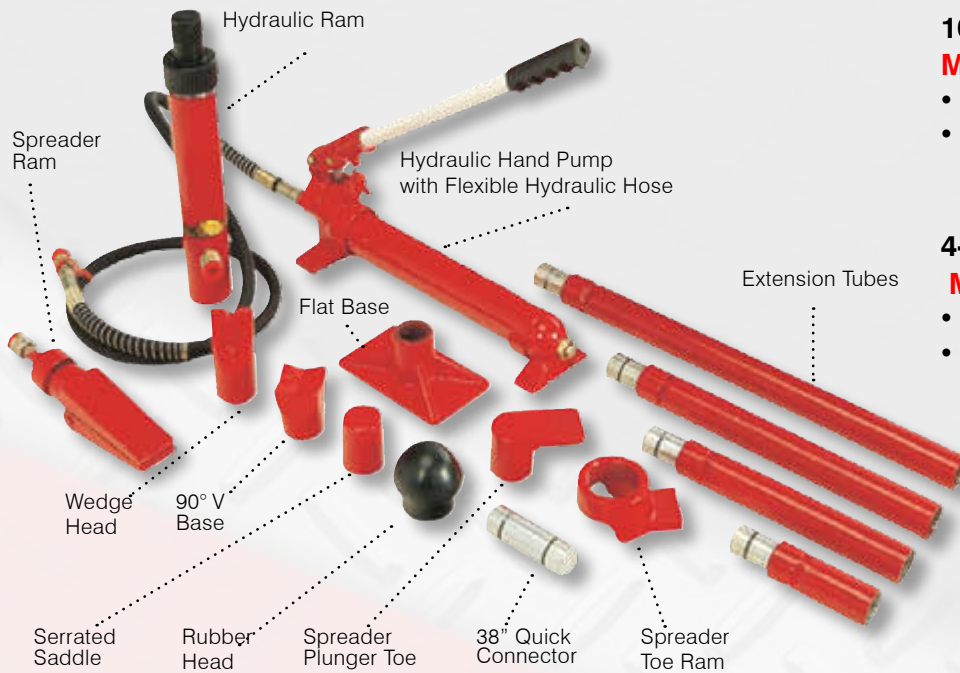

10-TON COLLISION REPAIR KIT

MODEL 815, 815C, 5815C

- See kit contents below
- Comes in either plastic or metal cases (see below)

4-TON COLLISION REPAIR KIT

MODEL 814, 814C

- See kit contents below
- Comes in either plastic or metal cases (see below)



10-TON COLLISION REPAIR KIT

MODEL 815C

- 10-Ton, Plastic case
- Ship weight 83 lbs.

MODEL 815

- 10-Ton, Steel Case
- Ship weight 87 lbs.

MODEL 5815C

- 10-Ton Economy Model
- Plastic case with wheels
- Ship weight 73 lbs.



4-TON COLLISION REPAIR KIT

MODEL 814

- 4-Ton, Steel Case
- Ship weight 49 lbs.

MODEL 814C

- 4-Ton, Plastic Case
- Ship weight 43 lbs.



Each kit includes:

- Either the AFF Model 814-41 4-Ton ram or Model 815-41 10-Ton ram
- Model 814-11 spreader ram
- Either Model 814-40 or 815-40 hydraulic hand pump with overload protection
- 5", 10", 21" and 24" extension tubes
- 3-1/4" extension tube (814 and 814C only)
- Rubber head
- Wedge head
- Spreader ram plunger toes
- Serrated saddle
- Rubber-faced flat base
- 90° V-base
- Quick connector
- Model 814K42 72" hydraulic hose
- Carrying case

AFF Air/Hydraulic Foot and Hand Pumps are precision made with the highest quality material and components providing durable unit for years of service. Each unit produces 10,000 PSI with overload protection.

4-TON HAND PUMP

MODEL 814-40

- Develops up to 10,000 PSI pressure with overload protection
- 16 cu. in. oil capacity
- Exact replacement for hand pump in AFF Model 814 series 4-Ton Body and Frame Repair Kits
- Ship weight 11 lbs.



10-TON HAND PUMP

MODEL 815-40

- Develops up to 10,000 PSI pressure with overload protection
- 33 cu. in. oil capacity
- Exact replacement for hand pump in AFF Model 815 series 10-Ton Body and Frame Repair Kits
- Ship weight 15 lbs.



10-TON CAPACITY AIR/HYDRAULIC FOOT PUMP

MODEL 801

- Converts rams from manual to air/hydraulic operation
- Develops up to 10,000 PSI pressure with overload protection
- Will operate all AFF rams
- Operates at 90 to 120 PSI
- 19.95 oz. oil capacity
- 17-1/2" length
- Ship weight 12 lbs.



10-TON CAPACITY AIR/HYDRAULIC FOOT PUMP

MODEL 802

- Rugged lightweight aluminum reservoir
- Converts rams from manual to air/hydraulic operation
- Will operate all AFF rams including large diameter & multiple ram configurations
- Operates at 90 PSI and up
- Quick displacement of up to 54.08 oz. hydraulic fluid
- Develops up to 10,000 PSI pressure
- Ship weight 19 lbs.



MODEL 804-07

2 Ton Capacity Compact Pull Kit with 9" to 14" reach
Ship weight 15 lbs.

MODEL 804-08

5 Ton Capacity Chain Pull Kit with 11-3/4" to 17-1/2" reach
Ship weight 15 lbs.

MODEL 804-09

10 Ton Capacity Pull Kit & Hooks with 12" to 17" reach
Ship weight 11 lbs.

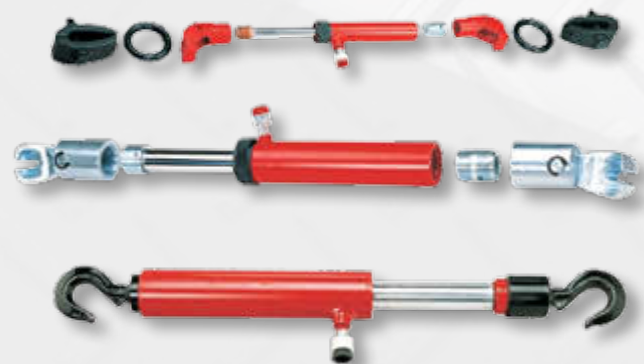

6 FOOT HYDRAULIC HOSE (not shown)

MODEL 814K42

10,000 PSI capacity replacement hose for AFF body & frame repair kits or for use with AFF rams and pumps
Ship weight 2 lbs.

RAM HALF COUPLER (not shown)

MODEL 4KR20

1/4" high flow coupler for quicker hydraulic system set-up. Develops 10,000 PSI capacity. 1/4" NPT female connection. For use with all AFF pumps and rams. Ship weight 1 lb.

COMPLETE RAM COUPLER SET (not shown)

MODEL 4KR22

Complete 1/4" NPT quick coupler. For use with all AFF pumps and rams. Ship weight 1 lb.



AFF Hydraulic Rams are premium quality, designed to provide trouble-free service to meet a wide range of needs. They are used to provide 1/2 to 10 tons of reliable, concentrated force in lifting, pulling, pushing, bending and alignment applications. AFF's ram models include mini, snap-style, screw, pull, wedge and long configurations that can be used with AFF and other body and frame repair kits as well as in vehicle service facilities, farms, industry and construction.



MODEL	CAPACITY (tons)	TYPE	STROKE	COMPRESSED LENGTH	EXTENDED LENGTH	SPRING RETURN	SHIP WEIGHT (lbs.)
810-07B	10	Mini	2"	4-3/4"	6-3/4"	Yes	6
814-41	4	Snap-style	5"	11"	16"	Yes	4
810-41	10	Screw	6"	15"	21"	Yes	10
810-45	10	Long	10"	15-3/4"	25-3/4"	Yes	13
812-45	2	Pull	5"	9-1/2"	14-1/2"	Yes	4
812-41	2	Mini	3."	4-3/4"	9-1/2"	No	2
815-41	10	Snap-style	6"	15"	21"	Yes	12
804-41	4	Screw	5"	9-3/4"	14-3/4"	Yes	4
804-11	1/2	Wedge	NA	1/2"	4"	N/A	5
804-10	4	Mini	5/8"	1-1/2"	2-1/4"	No	3
LRC8B (not shown)	8	Long	20-3/4"	24-1/4"	45"	N/A	35
LRC3B	3	Long	20-3/4"	24-1/4"	45"	N/A	25

Collision Repair



AFF's Engine Cranes are designed for the easy and efficient removal and transport of vehicle engines. All feature four-position telescopic booms, wide stable bases, forged steel hooks with safety latches and heavy-duty swivel casters.

4400 LB. CAPACITY ENGINE CRANE

MODEL 3580A

A high capacity engine crane with added boom length, enabling it to be used on vehicles with long front ends where an extra long reach is required.

- Boom extends between 49" and 76"
- Base legs extend between 60" and 80" to maximize stability
- Frame legs increase from 26" to 33" in width at full extension
- Roller-bearing swivel casters with safety brakes to secure positioning

(Shown with optional Model 582 Engine Tilter)



MODEL	CAPACITY (lbs.)	Boom (lbs) Capacity				Boom Height Minimum				Boom Height Maximum				Ship Weight
		1	2	3	4	1	2	3	4	1	2	3	4	
3580A	4400	4400	3300	2200	1100	38"	35"	31"	27"	88"	96"	101"	106"	221 lbs.

4400 LB. CAPACITY FOLDABLE ENGINE CRANE

MODEL 3988

The 3988 legs fold up and away, and with the ram completely retracted, give this unit an extremely small storage footprint.

- Boom extends between 40" and 63"
- 69" base length
- Fits into a 57" H x 12" W x 27" D space when folded



MODEL	CAPACITY (lbs.)	Boom (lbs) Capacity				Boom Height Minimum				Boom Height Maximum				Ship Weight
		1	2	3	4	1	2	3	4	1	2	3	4	
3988	4400	4400	3300	2200	1100	NA	NA	NA	NA	80"	84"	89"	93"	225 lbs.

2200 LB. CAPACITY FOLDABLE ENGINE CRANE

MODEL 988D

Similar in design to the 3988, the 988D also conveniently folds up for smaller storage area.

- Boom extends between 36" and 46"
- 60" base length
- Fold up legs reduce storage space required when not in use
- Ship weight 152 lbs.



MODEL	CAPACITY (lbs.)	Boom (lbs) Capacity				Boom Height Minimum				Boom Height Maximum				Ship Weight
		1	2	3	4	1	2	3	4	1	2	3	4	
988D	2200	2200	1500	1000	500	NA	NA	NA	NA	78"	80"	83"	91"	152 lbs.



1,000 LB. TRUCK MOUNTED CRANE

MODEL 3586B

- Rugged steel construction
- Boom working range 26.75" to 41.25"
- Locking swivel base - 360 degree swivel
- Heavy duty chain with safety lock
- Hydraulic operation provides easy lifting to desired height
- Designed to be installed in truck beds or vans
- Includes mounting plate & chain with grab hook
- Lifting range 0-70"
- Ship Weight 106 lbs.



Shown in DOWN position



2200 LB. CAPACITY ENGINE TILTER

MODEL 582

Can be used with all model AFF cranes, as well as competitive models to efficiently change an engine's center-of-gravity when installing or removing from a vehicle.

- 23-1/2" wide support bracket easily attaches to the engine for lifting security
- Ship weight 19 lbs.



Shown with Model 3580A Engine Crane



1100 LB. CAPACITY ENGINE SUPPORT

MODEL 583

- Provides overhead engine support for removal of trans axle on FWD vehicles
- Ideal for four- and six-cylinder, FWD vehicles
- Adjusts from 26-1/2" to 49-1/2" wide with 18-3/4" screw travel
- Ship weight 38 lbs.

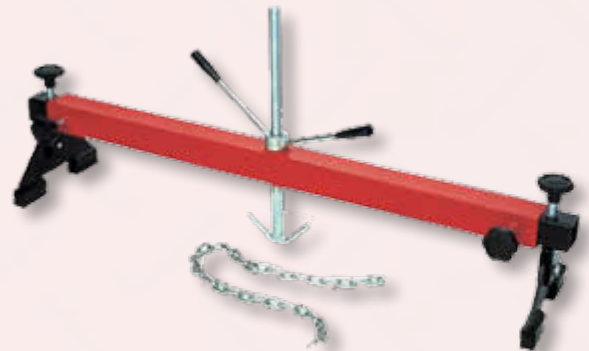

700 LB. CAPACITY TRANSVERSE. ENGINE SUPPORT W/ADDED SUPPORT BAR

MODEL 584

- Three support points for added stability
- 700 lb. Capacity
- 2 - 14" adjustable hook screws
- 2 - 1/8" x 38" braided steel cables
- Width expands from 34.5" to 61"
- Ship weight 27 lbs.



AFF Engine Stands are used in the positioning and transport of automobile and light truck engines in a wide variety of vehicle service facilities. All AFF Engine Stands include a 360° rotating head, which efficiently puts the engine in the optimal work position, rugged full swivel casters and heavy-duty tubular steel construction. Superior welds in all locations provide maximum strength and durability.

2000 LB. CAPACITY ENGINE STAND

MODEL 574

- Extra wide 4 point “U” type base ensures maximum stability and performance
- Adjustable brackets allow maximum flexibility – fits most automobile, light truck and diesel engines in heavy duty and super heavy duty pick up trucks
- 360° rotating head enables engine to be placed in desired work position
- Features convenient tray for holding tools and parts



MODEL	CAPACITY (lbs)	LENGTH	FRONT WIDTH	REAR WIDTH	SHIP WEIGHT
574	2000	40-1/2"	32-1/2"	32-1/2"	138 lbs.

2000 LB. CAPACITY FOLDING ENGINE STAND

MODEL 578

- Stable “V” base design
- 1 Ton capacity for heavy-duty applications
- Folds to fit in compact storage spaces
- Adjustable brackets allow maximum flexibility – fits most automobile, light truck and diesel engines in heavy duty and super heavy duty pick up trucks
- 360° rotating head enables engine to be placed in desired work position



MODEL	CAPACITY (lbs)	LENGTH	FRONT WIDTH	REAR WIDTH	SHIP WEIGHT
578	2000	43"	35"	21"	106 lbs.



1250 LB. CAPACITY ENGINE STAND

MODEL 573B

- Extra wide 4 point "U" type base ensures maximum stability and performance
- Adjustable brackets allow maximum flexibility – fits most automobile and light truck engines
- 360° rotating head enables engine to be placed in desired work position
- Full swivel casters
- Heavy duty welded steel base
- Features convenient tray for holding tools and parts



MODEL	CAPACITY (lbs)	LENGTH	FRONT WIDTH	REAR WIDTH	SHIP WEIGHT
573B	1250	34"	33"	33"	83 lbs.

1000 LB. CAPACITY ENGINE STAND

MODEL 571B

- Wide 4 point "H" type base ensures good stability
- Adjustable brackets allow maximum flexibility – fits most small engines
- 360° rotating head enables engine to be placed in desired work position
- Full swivel casters
- Heavy duty welded steel base



MODEL	CAPACITY (lbs)	LENGTH	FRONT WIDTH	REAR WIDTH	SHIP WEIGHT
571B	1000	36"	19-1/2"	33-1/4"	67 lbs.



AFF SUPER DUTY Shop Presses. The welded frame and heavier gauge steel make these presses ideal for heavy duty truck applications, spring shops, industrial, or every day shops that find themselves in need of a “step up” from a regular duty press. A movable press head assembly and included V-blocks add versatility to these work horses. To complete the package, these new presses come complete with foot operated air motor assist pin, press adapter kit and mountable/removable retracting guard for added safety.

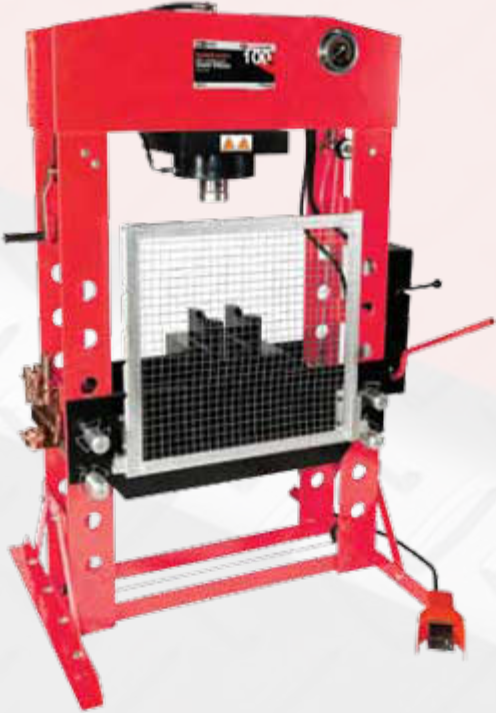

**100 TON SUPER DUTY SHOP PRESS
MODEL 859SD**

- Welded frame for added strength
- Protective guard, combination 'V' block and pressing adapter set included
- Press head moves from side to side for added pressing flexibility
- Liquid filled gauge accurately shows operator pressing force being applied
- Air pressure: 110 - 120 PSI
- HD cable winch for raising and lowering press bed
- Includes multiple use pin and press adapter kit

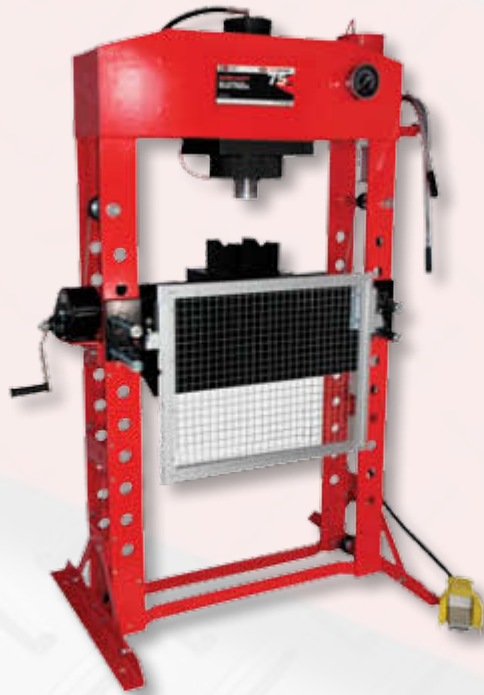

**75 TON SUPER DUTY SHOP PRESS
MODEL 856SD**

- Welded frame for added strength
- Protective guard, combination 'V' block and pressing adapter set included
- Press head moves from side to side for added pressing flexibility
- Liquid filled gauge accurately shows operator pressing force being applied
- Air pressure: 110 - 120 PSI
- HD cable winch for raising and lowering press bed
- Includes multiple use pin and press adapter set

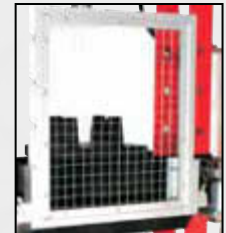
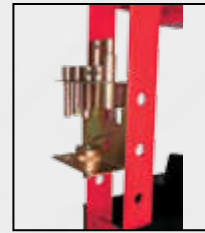
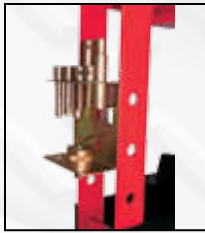

Model	CAPACITY TONS	RAM STROKE	OVERALL DIMENSIONS	BED DEPTH	BED WIDTH	THROAT DEPTH	THROAT WIDTH	SHIP WEIGHT
859SD	100	11.58"	55" W x 84" H	13.50"	31"	9"	16.5"	1476 lbs.
856SD	75	9.75"	57" W x 77" H	10.87"	31.5"	8"	19.75"	1039 lbs.



50 TON SUPER DUTY SHOP PRESS

MODEL 854SD

- Welded frame for added strength
- Protective guard, combination 'V' block and pressing adapter set included
- Press head moves from side to side for added pressing flexibility
- Liquid filled gauge accurately shows operator pressing force being applied
- Air pressure: 110 - 120 PSI
- HD cable winch for raising and lowering press bed
- Includes multiple use pin and press adapter set (not shown)

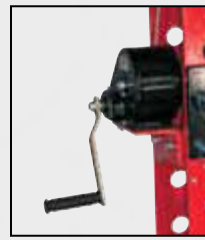

Model	CAPACITY TONS	RAM STROKE	OVERALL DIMENSIONS	BED DEPTH	BED WIDTH	THROAT DEPTH	THROAT WIDTH	SHIP WEIGHT
854D	50	7.75"	54" W x 75" H	10.125"	28.75"	7.25"	16.75"	660 lbs.

30 TON SUPER DUTY SHOP PRESS

MODEL 852SD

- Welded frame for added strength
- Protective guard, combination 'V' block and pressing adapter set included
- Press head moves from side to side for added pressing flexibility
- Liquid filled gauge accurately shows operator pressing force being applied
- Air pressure: 110 - 120 PSI
- Includes multiple use pin and press adapter set

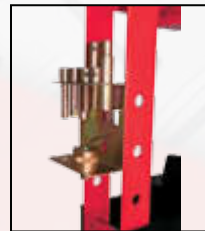

Model	CAPACITY TONS	RAM STROKE	OVERALL DIMENSIONS	BED DEPTH	BED WIDTH	THROAT DEPTH	THROAT WIDTH	SHIP WEIGHT
852D	30	5.9"	40" W x 71" H	7.25"	21.5"	6.5"	15"	363 lbs.

20 TON SUPER DUTY SHOP PRESS

MODEL 850SD

- Welded frame for added strength
- Protective guard, combination 'V' block and pressing adapter set included
- Press head moves from side to side for added pressing flexibility
- Liquid filled gauge accurately shows operator pressing force being applied
- Air pressure: 110 - 120 PSI
- Includes multiple use pin and press adapter set

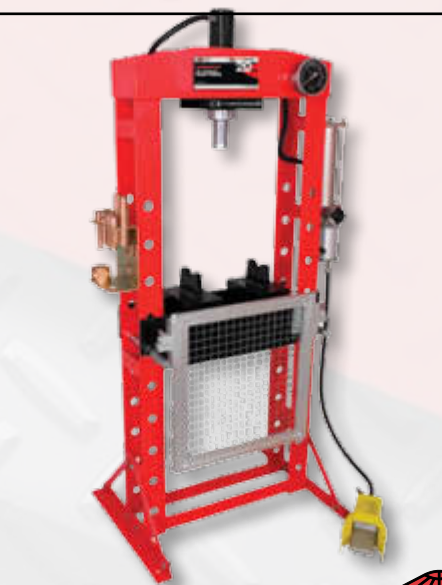
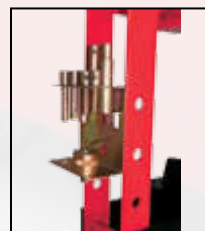

Model	CAPACITY TONS	RAM STROKE	OVERALL DIMENSIONS	BED DEPTH	BED WIDTH	THROAT DEPTH	THROAT WIDTH	SHIP WEIGHT
850D	20	7.5"	35" W x 64" H	7"	19.25"	5.75"	10.75"	282 lbs.



AFF Shop Presses, both bench and floor style, are used in repair shops for the removal and installation of gears, bushings and bearings, as well as with metal bending, straightening, compression and flattening applications. All AFF floor presses have “forge-tough” structural steel frames and two arbor plates.

50 TON CAPACITY FLOOR PRESS

MODEL 837

- Heavy-duty vehicle and industrial use
- Winch-operated press bed with seven adjustment levels
- Two-speed hand pump provides faster travel to load while air/hydraulic pump (with overload protection) provides effortless operation
- Frame-mounted hydraulic pressure gauge



MODEL	CAPACITY (tons)	STROKE	SPACE INTERVAL	BED RAIL OPENING	POST OPENING	BASE WIDTH	HEIGHT	SHIP WEIGHT
837	50	7"	5-1/2"	9"	32"	44"	68"	672 lbs

35 TON CAPACITY FLOOR PRESS

MODEL 834

- Automotive and heavy-duty use
- Two-speed hand pump provides faster travel to load while the air/hydraulic (with load protection) allows for effortless operation
- Seven bed adjustments
- Frame-mounted hydraulic pressure gauge



MODEL	CAPACITY (tons)	STROKE	SPACE INTERVAL	BED RAIL OPENING	POST OPENING	BASE WIDTH	HEIGHT	SHIP WEIGHT
834	35	6-1/2"	4-1/2"	7-1/2"	24"	30"	66"	312 lbs.

30 TON CAPACITY FLOOR PRESS

MODEL 832A

- Automotive and light industrial use
- Eight level bed adjustment
- 30 Ton bottle jack with overload protection
- Heavy-duty return springs for fast ram retraction
- Reinforced head plate



MODEL	CAPACITY (tons)	STROKE	SPACE INTERVAL	BED RAIL OPENING	POST OPENING	BASE WIDTH	HEIGHT	SHIP WEIGHT
832A	30	6-1/2"	4-1/2"	7-1/4"	22-1/2"	30"	66"	405 lbs.



20 TON CAPACITY FLOOR PRESS

MODEL 820A

- Automotive and light industrial use
- Eight level bed adjustment
- 20 Ton bottle jack with overload protection
- Heavy-duty return springs for fast ram retraction
- Reinforced head plate



MODEL	CAPACITY (tons)	STROKE	SPACE INTERVAL	BED RAIL OPENING	POST OPENING	BASE WIDTH	HEIGHT	SHIP WEIGHT
820A	20	8-1/2"	4-1/2"	7-1/4"	22-1/2"	27"	61"	280 lbs.

12 TON CAPACITY FLOOR PRESS

MODEL 812

- Designed for light duty applications
- Seven level bed adjustment
- Heavy-duty return springs for fast ram retraction
- Ship weight 112 lbs.



MODEL	CAPACITY (tons)	STROKE	SPACE INTERVAL	BED RAIL OPENING	POST OPENING	BASE WIDTH	HEIGHT	SHIP WEIGHT
812	12	6-3/4"	3-1/2"	3"	16"	20"	70"	112 lbs.

REPLACEMENT ARBOR PLATES

MODEL 812K20

Arbor plate fits Model 812 12 Ton Floor Press

MODEL 820AK7

Pair of arbor plates fits Model 820A 20 Ton Floor Press

MODEL 832AK12

Pair of arbor plates fits Model 832A 30 Ton Floor Press

MODEL 1001

Pair of arbor plates fits Model 837 50 Ton Floor Press



MODEL 820AK7



MODEL 832AK12

AFF JACK STANDS provide a safe and secure way to support vehicles once lifted and during under car maintenance. Our ratchet and pin-type stands are built using heavy steel with large support saddles. They are intended for use in pairs in automotive and fleet service as well as agricultural and construction equipment service facilities.

**3-TON JACK STAND SET
MODEL 3303**

- Notched saddles for use with unitized body vehicles
- Safety ratchet prevents lowering when saddle is loaded
- Convenient handle for release and carrying
- Adjusts from 11-3/4" to 17"
- 7" x 7-1/2" base
- Ship weight 16 lbs. per pair



**6-TON JACK STAND SET
MODEL 3306**

- Notched saddles for use with unitized body vehicles
- Safety ratchet prevents lowering when saddle is loaded
- Convenient handle for release and carrying
- Adjusts from 16" to 23-3/4"
- 9" x 10-1/2" base
- Ship weight 30 lbs. per pair



**12-TON JACK STAND SET
MODEL 3312**

- Notched saddles for use with unitized body vehicles
- Safety ratchet prevents lowering when saddle is loaded
- Convenient handle for release and carrying
- Adjusts from 17-3/4" to 28-1/2"
- 12" x 10-3/4" base
- Ship weight 62 lbs. per pair



**5-TON CAPACITY FORKLIFT
JACK STAND SET
MODEL 3305A**

- Pin-type post adjusts to four height positions from 13" to 17"
- Large 2-3/4" x 4" support saddles
- Heavy-duty 9" x 10" base secures and stabilizes load
- Ship weight 29 lbs. per pair



**10-TON CAPACITY TRUCK JACK
STAND
MODEL 3309A**

- Pin-type post adjusts to seven height positions from 18-1/2" to 30"
- Large 3-1/8" x 5-7/8" support saddle and wide 17" x 17" base
- Convenient carrying handle
- Sold individually
- Ship weight 37 lbs.



**10-TON CAPACITY TRUCK STAND
MODEL 3310A**

- Heavy duty, pin-type post adjusts to ten height positions from 28" to 47"
- Large 3-1/8" x 5-7/8" support saddle and stable 16" x 16" base
- Sold individually
- Ship weight 55 lbs.



**20-TON HEAVY-DUTY JACK STAND
MODEL 3314**

- Efficient pin-type post with four height adjustment positions
- Adjusts from 12" to 20"
- Large 3" x 5" saddle
- Stable 10" x 10" steel base
- Balanced carrying handle
- Sold individually
- Ship weight 50 lbs.



Stands



AFF Super Heavy Duty Truck Stands are designed for truck and bus support. Spring loaded caster wheels allow for easy positioning and portability. Non skid rubber saddle pad for secure placement.



Adjustable Height

FIXED HIGH TRUCK STAND

MODEL 3340SD

- 33,000 lb. capacity
- Adjustable height range from 57" to 82"
- 21-1" height adjustments with 4" fine adjustment by screw
- Spring loaded casters for ease of positioning
- Spring loaded tower for easy height adjustment
- Ship weight 232 lbs.



FIXED HIGH TRUCK STAND

MODEL 3342SD

- 15,000 lb. capacity
- Adjustable height range from 57" to 82"
- 21-1" height adjustments with 4" fine adjustment by screw
- Rubber pad protects vehicle from damage
- Spring loaded casters for ease of positioning
- Spring loaded tower for easy height adjustment
- Ship weight 134 lbs.



FIXED HIGH TRUCK STAND

MODEL 3344SD

- 15,000 lb. capacity
- Adjustable height range from 36" to 54"
- 17-1" height adjustments
- Rubber pad protects vehicle from damage
- Spring loaded casters for ease of positioning
- Ship weight 103 lbs.



Stands

20 TON WIDE STANCE TRUCK RAMPS

MODEL 3420SD

- Long retractable handle and wheels eases movement and stores easily out of the way
- Suitable for large truck tires up to 16" maximum width
- Comes with rubber non skid pad to prevent slippage
- 20 Ton capacity per pair
- Frame = 47" L x 18.25" W x 9.25" H
- Overall length = 51"
- Tread Width = 16"
- Ships one pair in wooden crate
- Ship weight 396 lbs. per pair



Retractable Handle

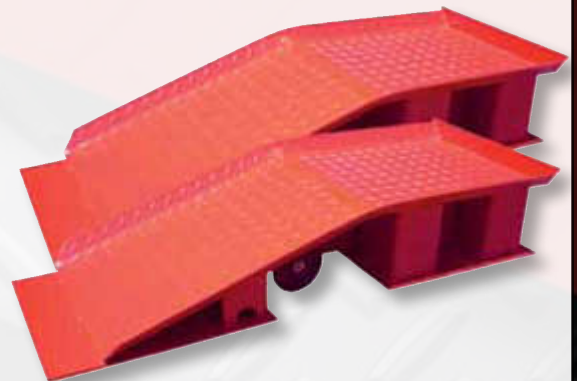

AFF Under-Hoist and Stabilizing Stands, built with all-steel construction, are designed to stabilize vehicle system components in under-hoist applications. Model 3318 can be used to stabilize loaded and unloaded trailers when not connected to trucks

Stands



**4000 LB. CAPACITY
UNDER-HOIST STAND**

MODEL 3315A

- Adjusts from 55" to 85-1/2"
- Ideal for exhaust and suspension work
- Bearing included for smooth operation
- Easily disassembles for storage
- 24" x 24" x 24" base
- Not designed to support entire vehicle
- Ship weight 44 lbs.



**1650 LB. CAPACITY
UNDER-HOIST STAND**

MODEL 3320A

- Adjusts from 54-1/2" to 80-1/2"
- Foot-operated lever for extra lift
- Bearing included for smooth operation
- 12" diameter base
- Not designed to support entire vehicle
- Ship weight 36 lbs.



**4000 LB. CAPACITY
STABILIZING STAND**

MODEL 3233A

- Adjusts from 66-1/2" to 73"
- Bearing included for smooth operation
- Adjusting screw for easier load positioning
- 21" x 21" x 21" base
- Not designed to support entire vehicle
- Ship weight 26 lbs.

**50-TON CAPACITY TRAILER
STABILIZING STAND**

MODEL 3318

- 100,000 lb. static load capacity
- 45,000 lb. lifting capacity
- Adjusts from 39" to 51"
- Pivoting, reversible ratchet head levels trailers on uneven ground
- Wide 14" diameter base for added stability
- Removable pipe handle
- Ship weight 157 lbs.



Meets OSHA requirements for stabilizing loaded and unloaded trailer



AFF Chain, Lever and Cable Hoists are the dependable way to lift, lower, load and move a variety of heavy materials with a minimum of manual power for maximum efficiency. Their primary applications include farming, industry, machine shops, trucking and so many more. AFF provides variety in its line of hoists

CHAIN HOISTS

- Factory tested to 150% of rated capacity
- Rugged triple spur gear
- Safety brake to prevent slippage
- Hardened steel alloy chain for safe, smooth operation
- Forged safety hooks included

MODEL 4001
2,000 CAPACITY
CHAIN HOIST



MODEL 4002
4,000 CAPACITY CHAIN
HOIST



MODEL 4003
6,000 LB. CAPACITY
CHAIN HOIST

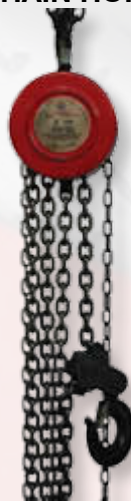

MODEL 4005
10,000 LB. CAPACITY
CHAIN HOIST



MODEL	CAPACITY (lbs.)	LIFT (ft)	CHAIN DIAMETER	# of FALLS	# OF SAFETY HOOKS	SHIP WEIGHT
4001	2,000	8	1/4"	1	2	23 lbs.
4002	4,000	10	1/4"	1	2	30 lbs.
4003	6,000	10	3/8"	2	2	50 lbs.
4005	10,000	10	5/16"	2	2	91 lbs.

MODEL 4008
3,000 LB. LEVER HOIST

- Durable steel frame
- Lightweight and easy to handle
- Guide slots to guard against jamming or slippage
- 1/4" link chain
- Two Forged safety hooks included
- Lift is 5 ft.
- 1 Fall
- Ship weight 25 lbs.



CABLE PULLERS

- Efficient for lifting, lowering, pulling & stretching applications
- Hardened steel pivot points for extra strength
- Forged safety hooks included

MODEL 30200
CABLE PULLER

- 4,000 lb. capacity
- 3/16" cable diameter
- 5' cable length
- Ship Weight 7 lbs.

MODEL 30400
CABLE PULLER

- 8,000 lb. capacity
- 3/16" cable diameter
- 5-1/2' cable length
- Ship Weight 14 lbs.



PALLET JACK

MODEL 3900A

- High tensile steel frame with 5500 lb. capacity
- Quick hydraulics lift from 3" to 7-3/4"
- Large 27" x 48" platform
- Full 180 degree steering arc
- Durable polyurethane-coated steel wheels and entry rollers
- Three position control lever automatically returns to neutral position
- Ship weight 228 lbs.

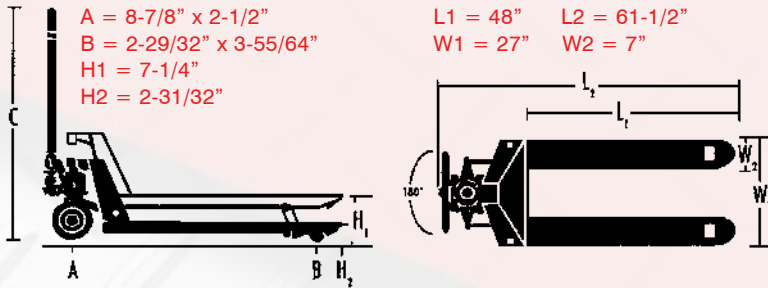

HEAVY-DUTY HAND TRUCK

MODEL 3903

- 550 lb. capacity
- 6" x 13-3/4" toe plate and integrated wheel guards
- P-shaped handle
- Large 10" pneumatic tires for ease of maneuverability
- 52" high
- Ship weight 26 lbs.



HYDRAULIC TABLE CART

MODEL 3904

- 1100 lb. capacity
- Foot pedal-operated table smoothly lifts and lowers engines, transmissions, heavy packages and cargo
- Lifts 32" x 19-1/2" table from 11" to 36"
- Heavy-duty, all-steel construction with four wheels and two wheel brakes
- Handle-mounted pressure release
- Large non-skid platform with wrap-around rubber bumper
- Ship weight 195 lbs.



13.2 GALLON DRUM BAND DOLLY

MODEL 8625

- Designed to efficiently move 13.2-gallon drums and pails
- Adjustable band clamp holds load securely
- Four rubberized casters for directional stability
- Ship weight 8 lbs.



55 GALLON DRUM BAND DOLLY

MODEL 8655

- 660 lb. capacity
- Move 55-gallon steel, plastic and fiber drums easily and safely
- Heavy-duty spot-welded steel construction
- Four 3" heavy-duty swivel casters for directional stability
- 24-3/8" band diameter
- Ship weight 24 lbs.



55 GALLON DRUM CRADLE

MODEL 8656

- 660 lb. capacity
- Tip, drain and store 55-gallon drums with ease (drum not included)
- Cradle supports drum 17" off floor
- Four wheels for easy positioning
- 34" L x 21" W x 17" H
- Ship weight 24 lbs.



PROFESSIONAL-DUTY GREASE GUN

MODEL 8000

- 10,000 PSI
- 14 oz. capacity via cartridge suction or bulk loading
- Heavy-duty, aluminum die-cast head
- Bulk loader & air bleeder valve
- Four-jaw coupler with ball check
- Ship weight 4 lbs.

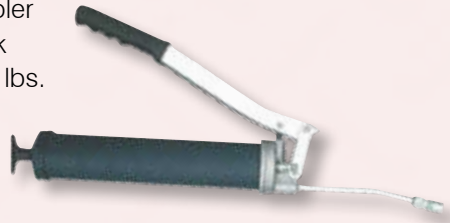

MEDIUM-DUTY GREASE GUN

MODEL 8001

- 8,000 PSI
- Aluminum die-cast head
- Four-jaw coupler with ball check
- 14 oz. capacity via cartridge, suction or bulk loading
- Ship weight 4 lbs.



STANDARD GREASE GUN

MODEL 8002

- 8,000 PSI
- Four-jaw coupler with ball check
- 14 oz. capacity via cartridge or suction
- Ship weight 4 lbs.



PISTOL-GRIP GREASE GUN

MODEL 8003

- 5,000 PSI with flexible hose
- Comfortable one-hand operation in confined spaces
- Heavy-duty aluminum die-cast head
- Four-jaw coupler with ball check
- 14 oz. capacity via cartridge or suction
- Ship weight 4 lbs.

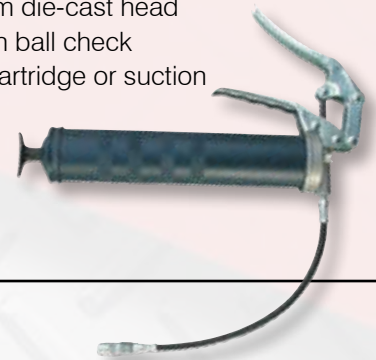

FLUID TRANSFER GUN

MODEL 8005

- Transfers liquids from one container to another
- 8 ft. of vinyl hose (4 ft. for each valve)
- Suitable for petroleum products
- Ship weight 3 lbs.



SUCTION GUN

MODEL 8006

- Transfers gear oils into and out of gear boxes, transfer cases and differentials.
- Single piece aluminum die-cast head
- 12" flexible vinyl hose
- 16 oz. capacity
- Ship weight 2 lbs.



DELUXE MINI-PISTOL GREASE GUN

MODEL 8007

- 3,500 PSI
- One-hand operation
- Aluminum die-cast head with front and top discharge ports
- Four-jaw coupler with ball check
- 3 oz. capacity
- Ship weight 5 lbs.



PNEUMATIC GREASE GUN

MODEL 8010

- 4,800 PSI
- 14 oz. capacity via cartridge, suction or bulk loading
- Single shot with every trigger pull
- Heavy-duty aluminum die-cast head
- 40:1 pressure ratio
- Four-jaw coupler
- Bulk loader valve
- Ship weight 5 lbs.



7-PC LUBRICATION KIT

MODEL 8090

- Model 8091: Needle adapter
- Model 8014: Whip hose with quick disconnect (QD) and heavy duty coupler
- Model 8025: Recessed QD lube adapter
- Model 8037: Rubber-tipped QD seal-off dispenser
- Model 8022: 1-1/2" narrow needle adapter (QD)
- Model 8034: Right angle adapter (QD)
- Model 8021: 90° adapter (QD)
- Cloth roll-up carrying case
- Ship weight 2 lbs.



GREASE GUN WHIP HOSES

MODEL 8012 - 12"

MODEL 8018 - 18"

- For hand-operated grease guns
- 3,500 PSI working pressure
- 11,600 PSI burst pressure
- 1/8" NPT threads



GREASE GUN WHIP HOSES

MODEL 8013 - 12"

MODEL 8019 - 18"

- Heavy duty spring guard for added durability/safety
- For hand-operated grease guns
- 3,500 PSI working pressure
- 11,600 PSI burst pressure
- 1/8" NPT threads



GREASE GUN WHIP HOSES

MODEL 8014 - 12"

- Quick disconnect
- Heavy duty coupler
- For hand-operated grease guns
- 3,500 PSI working pressure
- 11,600 PSI burst pressure
- 1/8" NPT threads



HIGH-PRESSURE GREASE GUN HOSES

MODEL 8612 - 12"

MODEL 8618 - 18"

- Polyamide inner tube with polyurethane sheathing
- 0.425" outer diameter
- 5,800 PSI working pressure (13,775 PSI burst)
- Zinc-plated end connections
- 1/8" NPT threads



90° LUBE ADAPTER (QD)

MODEL 8021

- Reach hidden fittings in shoulders & confined areas
- 0.24" greasing end diameter
- Locking sleeve
- For hand-operated grease guns only



1-1/2" NARROW NEEDLE ADAPTER (QD)

MODEL 8022

- Reach flush or hidden fittings
- 0.156" needle diameter
- Locking sleeve
- For hand-operated grease guns only



4" NEEDLE ADAPTER (QD)

MODEL 8023

- Dispense a fine line of grease
- For hand-operated grease guns only



QUICK DISCONNECT (QD) ADAPTER

MODEL 8024

- Grease fitting on one end and 1/8" NPT threads on the other
- For hand-operated grease guns only

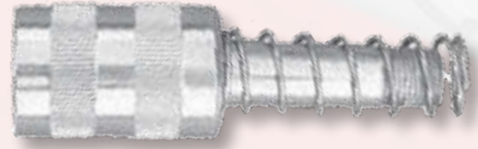

RECESSED LUBE ADAPTER (QD)

MODEL 8025

- For recessed fittings where hydraulic couplers can't reach
- Cup-shaped 0.22" diameter tip
- 0.31" body diameter, 3.15" length
- Locking sleeve
- For hand-operated grease guns only



1-1/2" NEEDLE ADAPTER

MODEL 8027

- Use to dispense a fine line of grease
- Reach flush or hidden hydraulic type fittings
- For hand-operated grease guns only
- 1/8" NPT threads



NEEDLE ADAPTERS

MODEL 8028 - 5/8"

- Use to dispense a fine line of grease
- Reach flush or hidden hydraulic type fittings
- For hand-operated grease guns only
- 1/8" NPT threads
- Zinc-plated end connections



NEEDLE ADAPTERS

MODEL 8029 - 6"

- Use to dispense a fine line of grease
- Reach flush or hidden hydraulic type fittings
- For hand-operated grease guns only
- 1/8" NPT threads
- Zinc-plated end connections



FINE-POINT NEEDLE ADAPTER

MODEL 8091

- For dispensing very fine line of grease
- Sharp point to inject grease into ball joints
- For hand-operated grease guns only



BULK LOADER VALVE

MODEL 8026

- Replacement valve for hand-operated grease guns only



GREASE GUN EXTENSION

MODEL 8030

- 6" length
- 1/8" NPT threads



GREASE GUN HOLDER

MODEL 8031

- Snap-action clamp for easy grease gun storage
- Standard (3,000 PSI)

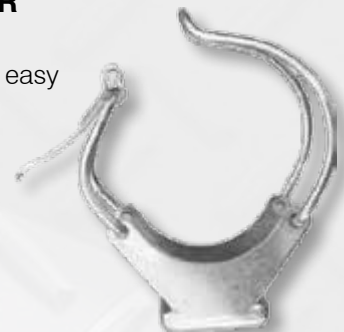

HYDRAULIC COUPLER

MODEL 8032

- Standard (3,000 PSI)



HYDRAULIC COUPLER

MODEL 8033

- Professional (6,000 PSI)
- Four-jaw coupler with ball check
- For hand-operated grease guns only



RIGHT-ANGLE GREASE COUPLER

MODEL 8034

- Polyurethane seal fits perfectly on fittings
- Hardened coupler housing slot provides 90° access
- For hand-operated grease guns only
- 1/8" NPT threads

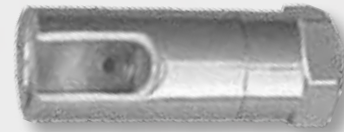

3-JAW SWIVELING COUPLER

MODEL 8035

- 360° swivel locks in any of eight 45° positions
- Adjustable coupler section
- 7,000 PSI maximum operating pressure

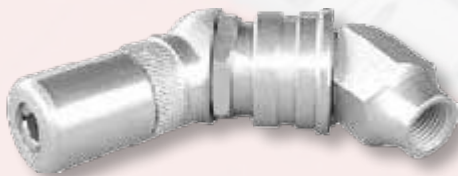

BEARING PACKER

MODEL 8036

- For greasing taper roller bearings with 1/2" min. inner diameter, 5" maximum outside diameter & height from 1/4" to 2"
- For hand-operated or power lube equipment



SEAL-OFF DISPENSER

MODEL 8037

- For lubricating cars with grease plugs
- For hand-operated grease guns only
- Threaded 1/8" female NPT

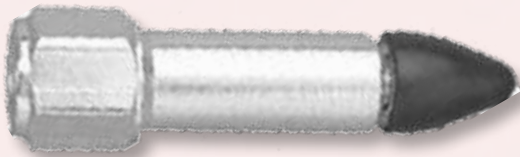

GREASE CONTROL VALVE

MODEL 8698

- Continuous grease flow with trigger depressed
- 1/4" NPT (f) inlet and 1/8" NPT (f) outlet threads
- For power lube equipment
- Ship weight 2 lbs.



360° "Z" SWIVELS 1/4" NPT (m) x 1/4" NPT (m)

MODEL 8687

- Heavy-duty steel installed between delivery hose and grease control valve prevents hose twisting



360° "Z" SWIVELS 1/4" NPT (m) x 1/2" 27 (m)

MODEL 8686

- Heavy-duty steel installed between delivery hose and grease control valve prevents hose twisting

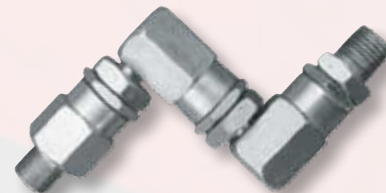

MODEL 8040

6 oz. Pistol style

MODEL 8041

6 oz. Long neck

MODEL 8042

7 oz. with 4" straight and flexible spouts

MODEL 8043

10 oz. with 4" straight and flexible spouts

MODEL 8044

16 oz. with 4" straight and flexible spouts

OIL CANS



Model 8040

Model 8041

Model 8042

Model 8043

Model 8044



POLYPROPYLENE ROTARY BARREL PUMP

MODEL 8075

- High-density polypropylene with Ryton vanes
- Three-piece extension tube with filter and 2" bung adapter
- Use with water, water-based chemicals, 50/50 antifreeze mix, windshield washer solvents, alcohol, and petroleum based products
- Works with DEF fluid
- Ship weight 5 lbs.

**DEF
Compatible**



HIGH-VOLUME ALUMINUM ROTARY PUMP

MODEL 8071

- Delivers over one quart per revolution
- Long-lasting die-cast aluminum construction with cast aluminum Buna-N-Seals
- Powder-coated finish with zinc-plated handle and discharge spout
- Curved metal spout, suction tube and bung adapter
- Use for transfer of petroleum based products
- Ship weight 13 lbs.



15-55 GALLON HAND ROTARY PUMP

MODEL 8070

- Cast iron pump housing with heavy-duty cast vanes and Nitrile rubber seals
- Three-section 37-1/4" telescopic suction tube with interchangeable bung adapters
- Use for diesel fuel and non-corrosive petroleum-based fluids of light-to-medium viscosity
- Ship weight 14 lbs.



LEVER-ACTION 15-55 GALLON BARREL PUMP

MODEL 8080

- For use with petroleum based fluids
- Hi-Nitrile rubber seals and packing
- Durable steel piston and foot valve
- Curved metal spout, 34-1/2" telescopic suction tube with 1-1/2" and 2" bung adapters. Use with oil-based fluids, heating oils and motor oils
- Delivers 10 oz. per stroke
- Ship weight 5 lbs.



LEVER-ACTION 15-55 GALLON ANTI-FREEZE BARREL PUMP

MODEL 8081

- Same as 8080 except..
- Designed for use with 100% anti-freeze, non-corrosive chemicals, oils and petroleum-based fluids



E-Z FLOW 5-GALLON OIL PUMP

MODEL 8060

- Designed for containers with Rieke or regular openings
- High-density polyethylene pump head with steel suction tube
- Interchangeable bung adapters
- Rigid steel outlet spout and 48" discharge tube
- Use for transfer of oils, diesel fuel and 100% antifreeze
- Delivers 1 quart per 15 strokes
- Ship weight 2 lbs.



BULK GREASE FILLER PUMP

MODEL 8038

- Fill grease guns through a bulk loader valve or with a bearing packer
- Fits 5-gallon (25-50 lb.) pails
- 11 1/8" rubber-lined follower plate
- Ship weight 5 lbs.



HIGH-PRESSURE (3500 PSI) GREASE PUMP

MODEL 8039

- Fits 5-gallon (25-50 lb.) pails
- Steel construction with aluminum head and pumping chamber
- Includes 12' drum cover, 11-1/8" rubber-lined follower plate
- 48" high-pressure flexible hose with steel extension and four-jaw coupler
- Use for clean, high-pressure volume greasing of cars, trucks, equipment and machinery
- Ship weight 9 lbs.



BUCKET LEVER PUMPS

MODEL 8050

5-Gallon (25 to 50 lbs)

MODEL 8051

16-Gallon (120 lbs)

- Designed for use with differential fluids or heavier oils
- 48" fuel-resistant PVC hose with nozzle
- Delivers 1 pint per stroke
- Ship weight 5 lbs. (Model 8050)
- Ship weight 9 lbs. (Model 8051)



18 GALLON WASTE OIL DRAIN WITH METAL TROLLEY

MODEL 8874

- 18-gallon capacity
- Comes with 16.5" funnel
- Extends from 40" to 73"
- Metal trolley comes with 4 casters and pull handle for safe and easier movement around the Shop.
- Oil can be drained either by pour gravity, integrated drain valve or using integrated bung hole rotary barrel pump (not included)
- Ship weight 24 lbs.



8 GALLON WASTE OIL DRAIN WITH METAL TROLLEY

MODEL 8870

- 8-gallon capacity
- Comes with 16.5" funnel
- Extends from 34" to 65"
- Metal trolley comes with 4 casters and pull handle for safe and easier movement around the shop.
- Ship weight 18 lbs.



30-GALLON HEAVY-DUTY TRUCK WASTE OIL EVACUATOR WITH CANTILEVER BASIN

MODEL 8880

- Safe removal of waste fluids through dipstick probes or by placing the cantilever basin beneath the truck or heavy equipment
- Large 30-gallon steel tank with 20-22 gallon evacuation capacity
- High-capacity 13.2-gallon cantilever basin (61-1/2" total unit height)
- Tank-mounted oil-level sight gauge and 6' drain hose
- Ship weight 152 lbs.



24-GALLON WASTE OIL DRAIN AND EVACUATOR WITH PROBE KIT

MODEL 8895

AFF provides waste fluid recovery through traditional gravity feed and dipstick probes with specialized adapters.

- 18-gallon suction capacity
- 100-PSI shop air connected to vacuum gauge quickly creates suction
- Large 16" collection funnel (4-7/8 gallon capacity)
- Suction extraction at 1/2 gallon per minute
- 78" suction and drain hoses
- Pressurized evacuation of tank makes emptying easy
- 70.8" maximum height
- Six flexible evacuation probes and VW, Mercedes and BMW adapters
- Two air ports: 1 for pressure, 1 for vacuum
- Ship weight 93 lbs.

24-GALLON WASTE OIL DRAIN AND PRESSURIZED EVACUATOR

MODEL 8890

- Large 24 gallon steel recovery tank with 6' drain hose
- Tank-mounted oil-level sight gauge and convenient tool tray
- Standard 15-3/4" drain funnel and wide 24" funnel adapter (shown) with drain tube that extends from 54" to 79"
- Pressure regulator
- Heavy-duty wheels and casters
- Ship weight 82 lbs.

5-GALLON PORTABLE OIL DRAIN

MODEL 8630

- Traditional gravity-fed portable drain adjusts to 72" for shop use
- Five-gallon holding tank with 13-1/2" wide drain funnel
- Four rugged casters
- Ship weight 15 lbs

REPLACEMENT STANDARD PLASTIC FUNNEL

MODEL 8890K08

Fits AFF Model 8890 24-Gallon Waste Oil Drain and Pressurized Evacuator.

- 15-3/4" wide
- Ship weight 8 lbs.

REPLACEMENT PLASTIC FUNNEL

MODEL 8630K1

Fits AFF Model 8630 5-Gallon Portable Oil Drain.

- 13-1/2" wide
- Ship weight 5 lbs.



50:1 AIR-OPERATED PORTABLE GREASE UNIT

MODEL 8600A

- For use with 5-gallon (35 lbs) containers
- 50:1 pump
- 70-100 PSI operating pressure
- Pumps up to 1.76 lbs. per minute
- 82 dB noise level
- Carrying handle
- 13' delivery hose
- 12.20" drum cover
- Control valve
- Ship weight 23 lbs.



50:1 AIR-OPERATED PORTABLE GREASE UNIT

MODEL 8622A

- 50:1 pump
- 70-100 PSI operating pressure
- Pumps up to 1.76 lbs./minute
- 82 dB noise level
- 13' delivery hose
- 15.10" drum cover
- 14-1/2" follower plate
- Control valve and 'Z' swivel
- Comes with 4-wheel cart
- Ship weight 54 lbs.



(Drum not included)

50:1 AIR-OPERATED PORTABLE GREASE UNIT

MODEL 8620A

- For use with 16-gallon (120 lbs) containers
- 50:1 pump
- 70-100 PSI operating pressure
- Pumps up to 1.76 lbs. per minute
- 82 dB noise level
- 13' delivery hose
- 15.10" drum cover
- 14-1/2" follower plate
- Control valve
- Ship weight 38 lbs.



(Drum not included)

MODEL 8620A PUMP w/MODEL 8625 BAND DOLLY

MODEL 8621A

- 50:1 pump
- 70-100 PSI operating pressure
- Pumps up to 1.76 lbs. per minute
- 82 dB noise level
- 13' delivery hose
- 15.10" drum cover
- 14-1/2" follower plate
- Control valve and 'Z' swivel
- Comes with 8625 drum dolly
- Ship weight 38 lbs.



Comes w/Model 8625 (Page 41)

(Drum not included)

50:1 AIR-OPERATED PORTABLE GREASE UNIT

MODEL 8650A

FOR USE WITH 55-GALLON CONTAINERS

Designed for vehicle & equipment maintenance facilities where 55-gallon grease drums are typically used. The high-pressure pump has a maximum free-flow rate of 1.76 lbs. per minute.

- Non-corrosive 50:1 pump moves grease up to NLGI #2
- Requires 70-100 PSI air pressure
- 1.18" diameter suction tube
- Durable grease control valve
- Unit includes heavy-duty "Z" swivel, drum cover, and follower plate
- 13' x 1/4" pressure hose
- Heavy-duty, zinc-plated drum cart with two large wheels and two casters
- Ship weight 84 lbs.



REPLACEMENT PUMPS

MODEL 8600AP

50:1 Air-Operated Grease Pump only for use with 5-gallon (35 lb.) containers. 70-100 PSI operating pressure. Pumps up to 1.76 lbs. per minute. 82dB noise level. Ship weight 12 lbs.

MODEL 8620AP

50:1 Air-Operated Grease Pump Only for use with 16-gallon (120 lb.) containers. Ship weight 14 lbs.



AFF Parts Washers are designed for fast and efficient cleaning of vehicle parts & subassemblies. Includes durable baked enamel finish and fusible-linked fire covers for safety. Our complete line of parts washers and accessories are designed for use with water-based cleaners (aqueous) for faster, more efficient cleaning.

7-GALLON PORTABLE PARTS WASHER

MODEL 31350

- 3-1/2 gallon working capacity
- 45 GPH pump output
- Safety GFCI plug at 115V/ 0.5A
- UL Listed on complete unit
- 18-1/2" x 13-1/2" x 9" overall dimensions
- Ship weight 18 lbs.



20-GALLON HYDRA-FLOW PARTS WASHER

MODEL 31200A

- 12-gallon working capacity
- 50 GPH pump output
- Safety GFCI plug at 115V/ 0.5A
- Removable work shelf and parts basket
- UL Listed on complete unit
- 30" x 20-1/2" x 36-1/2" overall dimensions
- Ship weight 62 lbs.



40-GALLON INDUSTRIAL-DUTY PARTS WASHER

MODEL 31400

- 22-gallon working capacity
- 50 GPH pump output
- Safety GFCI plug at 110V/0.5A
- Removable work shelf and parts basket
- UL Listed on complete unit
- 45" x 21-1/4" x 35-5/8" overall dimensions
- Ship weight 107 lbs.



FLO-THRU PARTS WASHER BRUSH

MODEL PWBRUSH

- Reduces parts cleaning time by 50%
- 4" long bristles suitable for use with water-based (aqueous) cleaner, as well as petroleum based product
- Easy attachment fitting
- Fits all AFF parts washers
- 10" L x 1-1/2" W
- Ship weight 2 lbs



HEAVY-DUTY WORKBENCHES are made of rolled edge steel (for safety) and are powdercoated to resist scratches, chips and rust. Each has sturdy 10-gauge steel worktops that can handle the weight of even the heaviest parts and assemblies. Bolt-down feet for added safety. Thick wall rectangular tubular legs create the sturdiest bench on the market. Ships in wooden crate.

HEAVY-DUTY WORKBENCH

MODEL 990

- 10-gauge rolled edge steel work top with 2" retaining wall on sides and back (1750 lb. load capacity)
- Two 12-gauge steel shelves each with a 550 lb. load capacity



MODEL	WORKTOP CAPACITY	DRAWERS	SHELF CAPACITY	# SHELVES	LENGTH	WIDTH	HEIGHT	SHIP WEIGHT
990	1750 lbs.	N/A	550 lbs.	2	79"	25-1/4"	34-1/2"	275 lbs.

HEAVY-DUTY WORKBENCH

MODEL 992

- 10-gauge rolled edge steel work top with 2" retaining wall on sides and back (1750 lb. load capacity)
- Two key-lock steel drawers with full-extension, ball-bearing slides
- One 12-gauge steel shelf with a 550 lb. load capacity



MODEL	WORKTOP CAPACITY	DRAWERS	SHELF CAPACITY	# SHELVES	LENGTH	WIDTH	HEIGHT	SHIP WEIGHT
992	1750 lbs.	2	550 lbs.	1	59"	25-1/4"	34-1/2"	236 lbs.

HEAVY-DUTY TEARDOWN TABLE

MODEL 994

- Fluids drain through table top into a removable plastic container (included)
- Comes with locking storage drawer on ball bearing slides
- Multiple shelf locations gives added versatility
- Square tube leg design gives added strength & stability to table top
- Large 4" heavy-duty swivel casters (2 locking)
- Table top features 1/2" rim
- Extra heavy duty construction
- Capacity: 1,000 lbs
- 47" W. x 31-1/2" D. x 39-3/4" H.
- Shipping weight: 168 lbs

Tapered table top with drain hole allows convenient fluid drainage into plastic container.



MODEL	WORKTOP CAPACITY	DRAWERS	SHELF CAPACITY	# SHELVES	LENGTH	WIDTH	HEIGHT	SHIP WEIGHT
994	1000 lbs.	1	1500 lbs.	1	48"	31"	40"	249 lbs.



CREEPER SEAT

MODEL 3906

- Padded, reinforced, oil-resistant vinyl seat (1-3/4" thick)
- Convenient under seat tray keeps tools and small parts handy
- 1" steel tube frame with four 2-1/2" ball-bearing casters
- Fully assembled
- 17-1/2" L x 14" W x 14" H
- Ship weight 10 lbs.



AIR PISTON CREEPER SEAT

MODEL 3907

- Padded, reinforced vinyl seat with air piston for efficient height adjustment to 18"
- Convenient under seat tool and parts tray
- Five 2-1/2" heavy-duty casters
- Ship weight 14 lbs.



42" HEAVY-DUTY MECHANICS' CREEPER

MODEL 3908

- Longer and wider for additional working comfort
- Drop frame at shoulder for ease of movement
- Full-length, padded, oil resistant vinyl center panel
- Six heavy-duty, dual-post casters
- 42" L x 21" W x 3-1/2" H
- Ship weight 21 lbs.



Double post caster mounting bolts are stronger, longer lasting and more durable

37" SIX-WHEEL PADDED CREEPER

MODEL 3905

- Full-length, padded, oil resistant vinyl center panel (1-3/4" thick)
- Additional 1-1/2" thick headrest
- Six 2-1/2" swivel casters
- 37" L x 18" W x only 3-1/2" H
- Ship weight 16 lbs.



Double post caster mounting bolts are stronger, longer lasting and more durable

MULTI-PURPOSE ROTARY BENCH VISE

MODEL 3195B

MODEL 3196

- Head and base rotate 360° for easy work positioning
- Replaceable flat and round steel pipe jaws
- Dual lock downs prevent jaws from inadvertently rotating



MODEL 3195B



MODEL 3196

MODEL	JAW WIDTH	JAW OPENING	SHIP WEIGHT
3196	6"	5"	101 lbs.
3195B	5"	4"	68 lbs.

GENERAL DUTY SWIVEL BENCH VISES

MODEL 3197

- 5" Jaw Width, Large Anvil
- Machined anvil surface
- Base rotates 360° for easy work positioning
- Replaceable steel jaws
- Dual locking handles
- Extra large anvil work surface

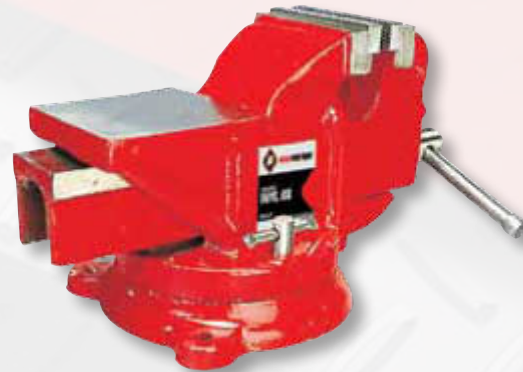

MODEL	JAW WIDTH	JAW OPENING	SHIP WEIGHT
3197	5"	6-1/2"	52 lbs.

LIGHT DUTY SWIVEL BENCH VISES

MODEL 3205

MODEL 3206

MODEL 3208

- Machined anvil surface
- Base rotates 360° for easy work positioning
- Replaceable steel jaws
- Dual locking handles



MODEL 3205



MODEL 3206



MODEL 3208

MODEL	JAW WIDTH	JAW OPENING	SHIP WEIGHT
3205	5"	4"	26 lbs.
3206	6"	5"	41 lbs.
3208	8"	6"	60 lbs.



TUBULAR FRAME LOCKING TOOL CART

MODEL 952

- Two 17" x 32" trays, one with locking lid
- Two locking, padded 26-3/4" x 15" x 3-1/4" drawers
- Heavy gauge steel with tough enamel finish
- Large 4" casters
- 32" L x 17" W x 39" H
- Ship weight 77 lbs.



TUBULAR FRAME LOCKING TOOL CART

MODEL 953

- Two 17" x 32" trays
- Removable locking 26" x 16" x 10" toolbox with two padded drawers
- Heavy gauge steel with tough enamel finish
- Large 4" casters
- 32" L x 17" W x 36" H
- Ship weight 74 lbs.



TUBULAR FRAME LOCKING TOOL CART

MODEL 951

- Two 17" x 32" trays with locking padded drawer
- Heavy gauge steel with tough enamel finish
- Large 4" casters
- 32" L x 17" W x 36" H
- Ship weight 53 lbs.



SERVICE CART

MODEL 958

- Heavy gauge steel with tough enamel finish
- Large 5" casters
- 36" L x 24" W x 33" H
- Ship weight 45 lbs.



12-TON CAPACITY PIPE BENDER

MODEL 9012

- Efficiently bends steel and aluminum thick-wall pipes (not for use with thin-wall conduit)
- Includes six bending shoes (1/2"; 3/4"; 1"; 1-1/4"; 1-1/2"; 2")
- Top rollers adjust up to 180° maximum bending capability
- Rugged 12-ton hydraulic bottle jack with handle
- Ship weight 93 lbs.



10-TON CAPACITY PIPE BENDER KIT

MODEL 900

- Efficiently bends 1/2" to 3" steel and aluminum thick-wall pipes
- Rugged two-speed 10 Ton hydraulic hand pump
- Includes eight bending shoes (1/2"; 3/4"; 1"; 1-1/4"; 1-1/2"; 2"; 2-1/2"; 3")
- 90° maximum bending capability
- Ship weight. 142 lbs.



WHEEL BEARING LOCKNUT SOCKETS

Locknut Sockets

- Machine welded 3/4" drive plate
- Precision engineered for an exact fit
- High tensile strength steel for added durability in high-volume applications
- Powder-coated finish for added rust protection
- Use with a heavy-duty ratchet, breaker bar or torque wrench
- Fits applications requiring hexagonal 6-point, hexagonal rounded 6-point and octagonal 8-point
- Label is double thick laser etched
- Precision welded drive strap
- Ships in easy stock shelf box

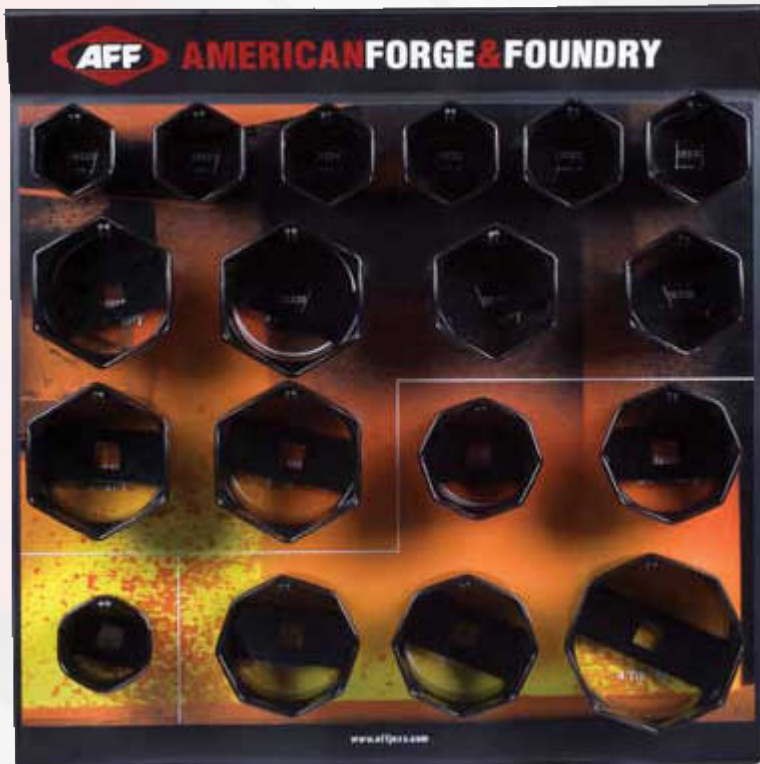

AFF #	Description	AFF #	Description	AFF #	Description
18501	2-3/32" (6pt.)	18514	4" (6pt.)	18527	3-13/16" (8pt.)
18502	2-3/8" (6pt.)	18515	4-1/8" (6pt.)	18528	2-9/16" (6pt)
18503	2-3/8" (8pt.)	18516	4-3/8" (6pt.)	18532	2-7/8" (6pt.)
18504	2-9/16" (6pt.)	18517	4-3/8" (8pt.)	18533	2-7/8" (8pt)
18505	2-9/16" (8pt.)	18518	4-7/8" (6pt.)	18534	3-1/8" (6pt.)
18506	3" (6pt.)	18519	4-7/8" (8pt.)	18535	3-1/8" (8pt.)
18507	3" (8pt.)	18520	2-1/4" (6pt.)	18536	2-3/8" (6R)
18508	3-1/4" (6pt.)	18521	2-1/2" (6pt.)	18537	2-3/4" (8pt.)
18509	3-1/4" (8pt.)	18522	2-5/8" (6pt.)	18538	4-1/2" (8pt.)
18510	3-1/2" (6pt.)	18523	2-3/4" (6pt.)	18539	5-1/4" (6pt.)
18511	3-1/2" (8pt.)	18524	3-3/8" (8pt.)	18540	4-1/8" (8pt.)
18512	3-7/8" (6pt.)	18525	3-3/4" (8pt.)	18541	4-13/16" (8pt.)
18513	3-7/8" (8pt.)	18526	3-3/4" (6pt.)		

VIKING 2 TON FOLDING ENGINE CRANE

MODEL 3020

- 4 Position boom extends for hard to reach applications
- 4 large swivel casters provide easier positioning
- Fold up legs reduce storage space required when not in use
- Folded footprint = 19" x 31.5"
- 31" leg opening, 31.5" rear base width
- Boom length 38.5" - 59.5"
- Base length 67"
- Ship weight 182 lbs.



VIKING RATCHETING FARM JACK

MODEL 3040

- 48" long
- 6600 lb. capacity
- Steel forged base 5.75" x 6.75"
- 32" long handle with grip
- 4" upper foot/4.5" lower foot
- Ship weight 34 lbs.





Our Viking Floor Jacks provide the quality and dependability of our AFF brand floor jacks at a superior value for car, home, shop or DIY use. Each comes with 360° swivel casters, safety valves to prevent overloading and a stance that provides greater stability under load.

VIKING 2-1/2 TON FLOOR JACK

MODEL 3001

- The ideal jack for smaller shop applications, with a 13-3/4" lift range.
- Two-piece 50-1/4" handle for easy maneuverability and storage
- Durable star gear drive release valve control
- Optional cross beam adapter
- Optional transmission adapter for removal/installation of transmissions



MODEL	CAPACITY (tons)	LOW HEIGHT	HIGH HEIGHT	CHASSIS LENGTH	OVERALL WIDTH (front)	OVERALL WIDTH (rear)	SHIP WEIGHT
3001	2-1/2	5-1/2"	19-1/4"	25-1/2"	8"	13-1/2"	83 lbs.

VIKING 3 TON DOUBLE PUMPER FLOOR JACK

MODEL 3003

Value and efficiency in a double-pumper jack, the Model 3003 will get the load in the air faster and safer. AFF's double-pumper advantage and safety overload system, make this the jack for the DIY customer and weekend mechanics.

- Universal joint technology for precision release valve control
- Two-piece 50-1/4" handle for easy maneuverability and storage
- Optional cross beam adapter (Model 3167 see page 7)
- Optional transmission adapter (Model 3165) for removal/installation of transmissions



MODEL	CAPACITY (tons)	LOW HEIGHT	HIGH HEIGHT	CHASSIS LENGTH	OVERALL WIDTH (front)	OVERALL WIDTH (rear)	SHIP WEIGHT
3003	3	5"	21"	28-1/2"	9"	13-1/2"	101 lbs.

VIKING 2 TON TROLLEY JACK

MODEL 3222D

Compact, lightweight and tough, the Viking Model 3222D is the jack you would want in your trunk.

- This unit is ideal for fleet use.
- Includes a convenient plastic carrying case.



MODEL	CAPACITY (tons)	LOW HEIGHT	HIGH HEIGHT	CHASSIS LENGTH	OVERALL WIDTH (front)	OVERALL WIDTH (rear)	SHIP WEIGHT
3222D	2	5"	15-1/2"	22"	5-1/2"	8-1/2"	30 lbs.

Viking Brand



AFF Product Displays increase sales Get yours today!

AFF Authorized Distributors

Contact your AFF Sales Representative for more information about displays and merchandising.



Heavy gauge powder coated
diamond plate shelves

Displays



AFF product displays can hold various items offering several different display options to maximize sales



Displays



WARRANTY

American Forge & Foundry, Inc. (AFF) warrants, to the final purchaser, all equipment distributed by AFF to be entirely free from operating defects in material and workmanship for a period of one year. If a jack or related equipment is determined to be defective during the period, AFF, at its option, will repair or replace without charge provided that the equipment is shipped, transportation charges prepaid, with proof of purchase, to AFF or to an authorized Field Service Depot designated by AFF.

This warranty does not apply to products damaged by accident, overload, misuse or abuse, nor does it apply to any product, which has been modified, altered or used with special attachments other than those expressly recommended by AFF. There are no other warranties express or implied, and Seller specifically disclaims any warranty of merchantability or of fitness for any particular purpose.

The Seller's sole obligation, which shall represent the Buyer's sole and exclusive remedy, shall be to repair or at the Seller's option to replace any product or part determined to be defective as aforesaid. In no event shall the Seller be liable for any special, direct, indirect, incidental, consequential or other damages of a similar nature, including, without limitation, loss of profits or of production time, or loss of expenses of any nature, incurred by the Buyer or any Third party.

MODEL NUMBER INDEX

4KR20	26	804-09	26	952	55
4KR22	26	804-10.....	27	953	55
200SS	5	804-11.....	27	956	55
200SSK43	7	804-41.....	27	958	55
200T	5	810-07B	27	988D	28
200TK40	7	810-41.....	27	990	52
200TK42	7	810-45.....	27	992	52
350GT	4	812	35	994	52
350GTK23	7	812-41.....	27	1001	35
350GTK41	7	812-45.....	27	2110A	6
350SS	4	812K20	35	2145	17
350SSK24	7	814	25	2158	16
390	7	814-40	26	2195A	17
522SD	8	814-41.....	27	3001	59
535A	9	814C	25	3003	59
544	8	814K42	26	3020.....	58
544EXT	8	815	25	3040.....	58
545SD	10	815-40	26	3120	12
546SD	10	815-41.....	27	3125	12
547SD	11	815C	25	3130	13
548SD	11	818SD	24	3135	13
549SD	11	818SD-40	24	3140	13
565E	9	818SD-41	24	3160	19
565E-HANDLE	9	820A	35	3165	7
565E1	9	820AK7	35	3167	7
571B	31	832A	34	3171	19
573B	31	832AK12	35	3172	19
574	30	834	34	3178	18
578	30	837	34	3180	18
582	29	850SD	33	3181	19
583	29	852SD	33	3190B	17
584	29	854SD	33	3190SS	16
801	26	856SD	32	3192A	16
802	26	859SD	32	3193	18
804-07	26	900	56	3195B	54
804-08	26	951	55	3196	54



MODEL NUMBER INDEX. Cont'd

3197	54	3905	53	8036	45
3198	18	3906	53	8037	45
3205	54	3907	53	8038	47
3206	54	3908	53	8039	47
3208	54	3911A	15	8040	45
3222D	59	3912A	15	8041	45
3233A	38	3917	6	8042	45
3303	36	3988	28	8043	45
3306	36	4001	39	8044	45
3305A	36	4002	39	8050	47
3309A	36	4003	39	8051	47
3310A	36	4005	39	8060	47
3312	36	4008	39	8070	46
3314	36	4502	23	8071	46
3315A	38	4503	23	8075	46
3318	38	4505	23	8080	46
3320A	38	4508	23	8081	46
3340SD	37	4512	23	8090	43
3342SD	37	4513	23	8091	44
3344SD	37	4522	23	8600A	50
3400A	14	4523	23	8600AP	50
3420SD	37	4535	23	8612	43
3502	22	4560	23	8618	43
3504	22	4599	23	8620A	50
3506	22	5512B	22	8620AP	50
3506C	22	5520B	22	8621A	50
3508	22	5815C	25	8622A	50
3512	22	8000	42	8625	41
3514	22	8001	42	8630	49
3520	22	8002	42	8630K1	49
3522	22	8003	42	8650A	50
3530	22	8005	42	8655	41
3550	22	8006	42	8656	41
3577	15	8007	42	8686	45
3580A	28	8010	42	8687	45
3586B	29	8012	43	8698	45
3590A	15	8013	43	8870	48
3591	15	8014	43	8874	48
3595A	15	8018	43	8880	48
3596	14	8019	43	8890	49
3598	14	8021	43	8890K08	49
3700	20	8022	43	8895	49
3749	21	8023	44	9012	56
3751	21	8024	44	30200	39
3752	21	8025	44	30400	39
3753	21	8026	44	31200A	51
3754	21	8027	44	31350	51
3755	21	8028	44	31400	51
3756	21	8029	44	35014P	7
3757	21	8030	44	LOCKNUT SOCKETS	57
3758	21	8031	44	LRC3B	27
3759	21	8032	45	LRC8B	27
3900A	40	8033	45	PWBRUSH	51
3903	40	8034	45		
3904	40	8035	45		



AMERICAN FORGE & FOUNDRY™

American Forge & Foundry
PO Box 59
Guilderland Center, NY 12085
800-255-0555
Fax: 518-861-0099
www.affjaxx.com
sales@affjaxx.com